



Russound®

CAM6.6

Six-Zone, Six-Source Controller

CAM6.6T

Six-Zone, Six-Source AM/FM Receiver

INSTRUCTION MANUAL



IMPORTANT SAFEGUARDS



 **WARNING:** TO REDUCE THE RISK OF FIRE OR ELECTRIC SHOCK, DO NOT EXPOSE THIS APPLIANCE TO RAIN OR MOISTURE.

 **CAUTION:** TO REDUCE THE RISK OF ELECTRIC SHOCK, DO NOT REMOVE COVER. NO USER - SERVICEABLE PARTS INSIDE. REFER SERVICING TO QUALIFIED SERVICE PERSONNEL.

The lightning flash with arrowhead symbol, within an equilateral triangle, is intended to alert the user to the presence of uninsulated "dangerous voltage" within the product's enclosure that may be of sufficient magnitude to constitute a risk of electric shock to persons.

The exclamation point within an equilateral triangle is intended to alert the user to the presence of important operating and maintenance (servicing) instructions in the literature accompanying the appliance.

POWER CORD NOTICE FOR INTERNATIONAL OPERATION
For 230V, 50Hz operation please select the power cord for your area. Select the plug for your area at one end and a IEC320 connector at the other. It is not necessary to make any other changes. If you have any questions please call Russound Inc. at 1-800-638-8055 or 603-659-5170

Safety Instructions:

1. Read Instructions - All the safety and operating instructions should be read before the appliance is operated.
2. Retain Instructions - The safety and operating instructions should be retained for future reference.
3. Heed Warnings - All warnings on the appliance in the operating instructions should be adhered to.
4. Follow Instructions - All operating and user instructions should be followed.
5. Water and Moisture - The appliance should not be used near water; for example, near a bathtub, washbowl, kitchen sink, laundry tub, in a wet basement, or near a swimming pool.
6. Carts and Stands - The appliance should be used only with a cart or stand that is recommended by the manufacturer. An appliance and cart combination should be moved with care. Quick stops, excessive force and uneven surfaces may cause the appliance and cart combination to overturn.
7. Wall or ceiling Mounting - The appliance should be mounted to a wall or ceiling only as recommended by the manufacturer.
8. Ventilation - The appliance should be situated so that its location or position does not interfere with its proper ventilation. For example, the appliance should not be situated on a bed, sofa, rug, or similar surface that may block the ventilation openings, or placed in a built-in installation, such as a bookcase or cabinet that may impede the flow of air through the ventilation openings.



9. Heat - The appliance should be situated away from heat sources such as radiators, heat registers, stoves, or other appliances (including amplifiers) that produce heat.
10. Power Sources - The appliance should be connected to a power supply only of the type described in the operating instructions or as marked on the appliance.
11. Grounding or Polarization - Precaution should be taken so that the grounding or polarization means of an appliance is not defeated.
12. Power Cord Protection - Power supply cords should be routed so that they are not likely to be walked on or pinched by items placed upon or against them, paying particular attention to cords at plugs, receptacles, and the point where they exit from the appliance.
13. Cleaning - The appliance should be cleaned only as recommended by the manufacturer.
14. Non-use Periods - The power cord of the appliance should be unplugged from the outlet when left unused for a long period of time.
15. Object and Liquid Entry - Care should be taken so that objects do not fall and liquids are not spilled into the enclosure through the openings.
16. Damage Requiring Service - The appliance should be serviced by qualified service personnel when:
 - A. The power supply cord or the plug has been damaged; or
 - B. Objects have fallen, liquid has been spilled into the appliance; or
 - C. The appliance has been exposed to rain; or
 - D. The appliance does not appear to operate normally; or
 - E. The appliance has been dropped or the enclosure is damaged.
17. Servicing - The user should not attempt to service the appliance beyond that described in the operating instructions. All other servicing should be referred to qualified service personnel.

Precautions:

1. Power – WARNING: BEFORE TURNING ON THE POWER FOR THE FIRST TIME, READ THE FOLLOWING SECTION CAREFULLY. All models are designed for use with either AC120V, 60Hz or AC240, 50Hz voltages. The unit will autoswitch to either of these voltages
2. Do Not Touch The Unit With Wet Hands – Do not handle the CAM6.6 or power cord when your hands are wet or damp. If water or any other liquid enters the CAM6.6 cabinet, take the CAM6.6 to a qualified service person for inspection.
3. Location of CAM6.6 – Place the CAM6.6 in a well - ventilated location. Take special care to provide plenty of ventilation on all sides of the CAM6.6 especially when it is placed in an audio rack. If ventilation is blocked, the CAM6.6 may overheat and malfunction. Do not expose the CAM6.6 to direct sun light or heating units as the CAM6.6 internal components temperature may rise and shorten the life of the components. Avoid damp and dusty places.
4. Care – From time to time you should wipe off the front and side panels of the cabinet with a soft cloth. Do not use rough material, thinners, alcohol or other chemical solvents or cloths since this may damage the finish or remove the panel lettering.



TABLE OF CONTENTS



USER SECTION

Product Introduction	5
Component Guide	
CAM6.6 Controller	6
UNO-S1 Keypad	7
UNO-S2 Keypad	8
UNO-TS2 Touchscreen	9
SRC2 Remote Control	10
Operation	
UNO-S1 Keypad Button Function	11
UNO-S1 User Menu	12
UNO-S2 Keypad Button Function	13
UNO-S2 User Menu	14
UNO-TS2 Touchscreen Button Function	15
UNO-TS2 - Setting Preferences	16
Internal Source - AM/FM Tuner	
UNO-S1 Keypad Control	17
UNO-S2 Keypad Control	18-19
UNO-TS2 Touchscreen Control	20-21
SRC2 Remote Control	22-23

INSTALLER SECTION

Getting Started	
Unpacking	25
Tools Needed	25
System Installation Considerations	25
Connection Tips	25
Component Guide	
CAM6.6 Controller Rear Panel	26-27
UNO Keypad OS Update Port	28
UNO Keypad Rear Panel	29
Wiring Instructions	
Keypad Wiring	30
Speaker Wiring	30
UNO-S2 IR Receiver Connection	31
Keypad Installation	
UNO Keypad Location	32
UNO Keypad Installation	32
Making Connections	
UNO Keypad Port Connections	33
Source Audio Input Connections	34
Source IR Input Connections	34
Common IR Input Connection	35



TABLE OF CONTENTS

Speaker Connections	36
Zone Fixed/Variable Audio Output	37
12VDC Home Theater Trigger In/Out.....	38
12VDC Mute Trigger In/Out	39
RNET Link In/Out	40
RS-232 Interface	41
AM/FM Tuner Antennas.....	42-44
Initial Install Test	45
Programming	
System Programming Overview.....	46-47
Installation Menu	
Installation Menu Overview.....	48
Peripheral Setup	49-51
Source Setup	51-57
Basic Setup	51-53
Zone Setup	58
Controller Setup.....	58-59
Power Management	59-61
Learn IR	61
Macro Editor.....	62-63
System Info.....	63
Setup Menu Flow Charts.....	64-76
Peripheral Setup: Memory Name, Bank Name.....	64
Peripheral Setup: Controller ID, Region, Factory Init, System Info	65
Basic Setup.....	66
Key Configuration	67
Source Names/Volume Trim	68
Numeric IR	69
Source Select Command/Number of Sources.....	70
Zone Setup	71
Controller Setup.....	72
Power Management	73
Learn IR	74
Macro Editor	75
System Info	76
Keypad Diagnostics Menu	77
REFERENCE SECTION	
IR Device Code List	78-81
IR Keycode List	82-103
Source Names	104-105
Source Information Form	106
Zone Information Form	107
Macro Editor Form	108
Sample Configurations.....	109-112
Technical Specifications.....	113
Warranty	114

PRODUCT INTRODUCTION



Thank you for choosing the Russound® CAM6.6 multisource, multizone controller to enhance your home with distributed audio. This controller's state-of-the-art features and components blend seamlessly with your unique lifestyle and preferences.

Besides distributing and controlling six audio sources to six rooms (zones) using RNET® keypads, your CAM6.6 offers many features that increase your enjoyment of living. Here are several that you may find particularly beneficial.

Favorites

These easy-to-set buttons make it possible to hear your favorite radio station or watch your favorite satellite channel at just the right volume in your room with just a button push. The F1 and F2 preset favorite buttons can be found on the SRC2 remote control, UNO-S2 keypad and UNO-TS2 touch-screen. Want something new? Just re-save the Favorite with a new choice.

Party Mode

Ready to set the mood? In Party Mode, you just pick the source and the sound settings and hear the music throughout all the rooms. The Master keypad simultaneously controls all the keypads in all the rooms to effortlessly select or control the components. A great benefit of the Party Mode feature is the ability to transfer the Master keypad mode to any keypad in the system. If the living room is the center of the party, use that room's keypad as Master. If the party moves to the sunroom and porch, that room's keypad can be set to Master instead.

Do Not Disturb

The Do Not Disturb setting prevents unwanted interruptions in your room and stops changes to your selected audio source. You may have a nursery or study that you want to keep quiet, or maybe you are watching a DVD and don't want it interrupted. Simply set the Do Not Disturb mode to "on" through the keypad's User Menu, and be free from Party Mode interaction and system-wide functions like "All On" or "All Off."

Internal Source

The CAM6.6T includes an internal source - an AM/FM tuner module. The tuner can store up to 36 favorites, or memory presets. These are stored in six groups (or banks) of six presets. Each preset and each bank can be given a custom name of your choice.

Here at Russound we are proud to continue providing innovative and intuitive audio product solutions to the world. When you link the industry-leading CAM6.6 with Russound's commitment to its products and customers, you have truly made – "the right connection."

USER COMPONENT GUIDE

CAM6.6 Controller-Front Panel

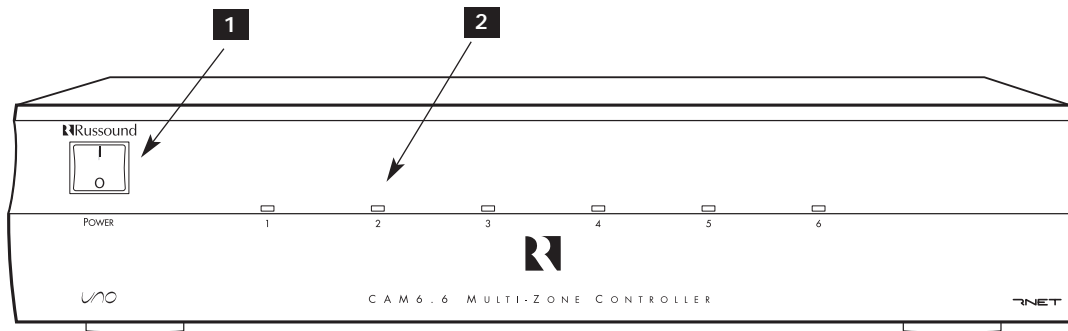

- 1** MAIN POWER SWITCH - Supplies power to the CAM6.6
- 2** ROOM LED ON/OFF INDICATORS - Indicates when a room is on (green) or off (red)

Main Power and Zone Status

The power switch for the CAM6.6 controller is "on" in the up position. Any active room (1-6) is indicated on the front of the controller by a green LED, which shows red when the room is inactive. In most basic installations, all functions and room settings are controlled through the corresponding UNO systems keypads.

UNO-S1 Keypad

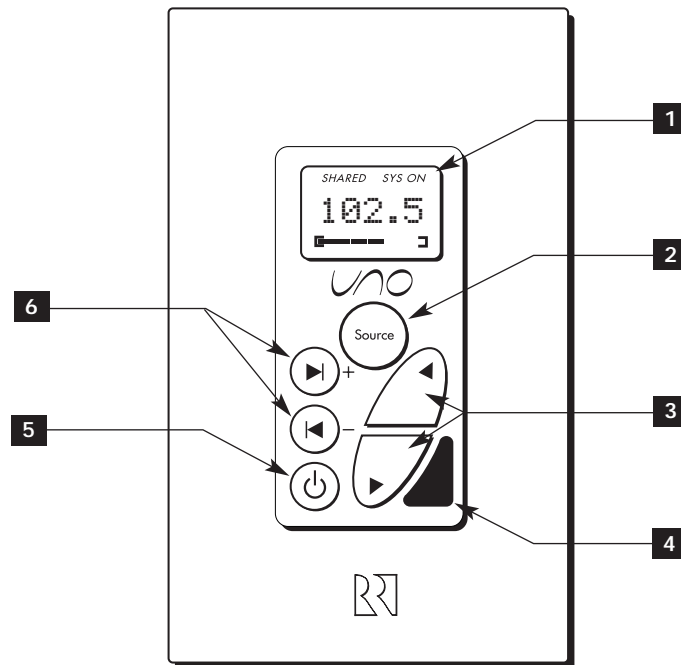

- 1** LCD PANEL - 5-character backlit display shows status of the room, source, volume, and more
- 2** SOURCE SELECT BUTTON - Scrolls through the sources directly connected to the CAM6.6. Press and hold brings up the USER MENU for loudness, bass, treble, etc.
- 3** VOLUME UP/DOWN BUTTONS - Raises and lowers the volume for the room
- 4** IR RECEIVER - Receives IR signals and passes them to the controller and source equipment. Also used when operating the UNO Keypad by using the SRC2 remote
- 5** POWER BUTTON - Turns room ON or OFF when pressed once, press and hold a second time will turn on or off all CAM6.6 rooms
- 6** COMMAND KEYS - Pressing the command keys controls the source equipment

 - **FORWARD** (press)
 - **DISC, CHANNEL UP** (press and hold)

 - **REVERSE** (press)
 - **DISC, CHANNEL DOWN** (press and hold)

USER COMPONENT GUIDE

UNO-S2 Keypad

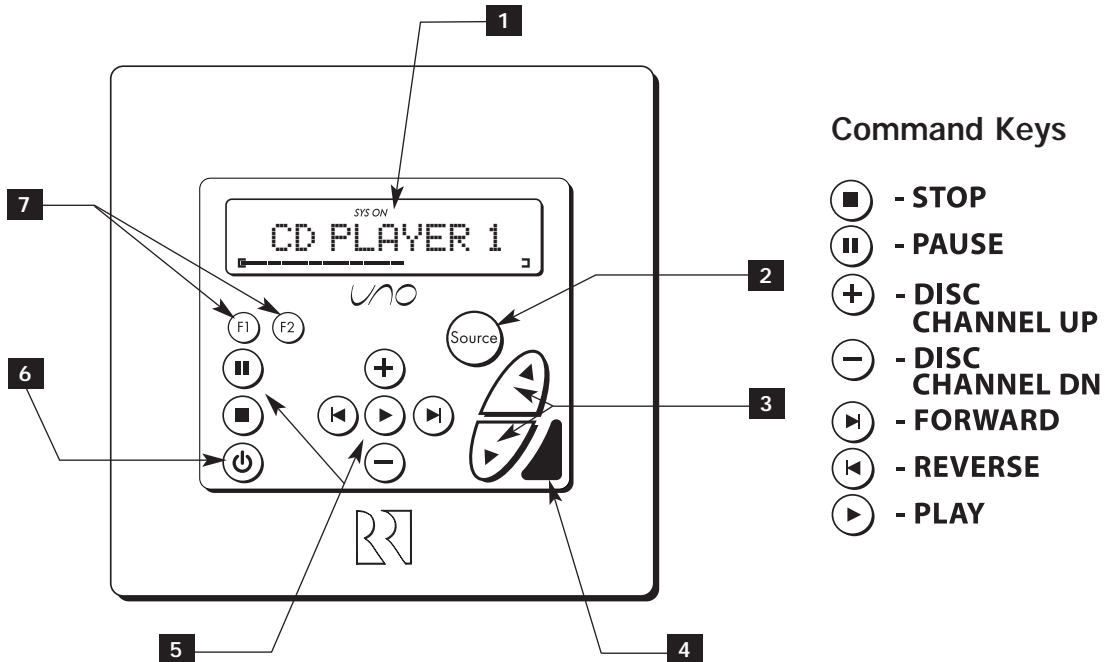

- 1** LCD PANEL - 12-character backlit display shows status of the room, volume, and more
- 2** SOURCE SELECT BUTTON - Scrolls through the sources directly connected to the CAM6.6. Press and hold brings up the USER MENU for loudness, bass, treble, etc.
- 3** VOLUME UP/DOWN BUTTONS - Raises and lowers the volume for the room
- 4** IR RECEIVER - Receives IR signals and passes them to the controller and source equipment. Also used when operating the UNO Keypad by using the SRC2 remote
- 5** COMMAND KEYS - Pressing the command keys controls the source equipment
- 6** POWER BUTTON - Turns room ON or OFF when pressed once, press and hold a second time will turn on or off all CAM6.6 rooms
- 7** F1 AND F2 BUTTONS - Selects Favorite 1 or Favorite 2 - preset user-selected favorite settings per room

USER COMPONENT GUIDE

UNO-TS2 Touchscreen

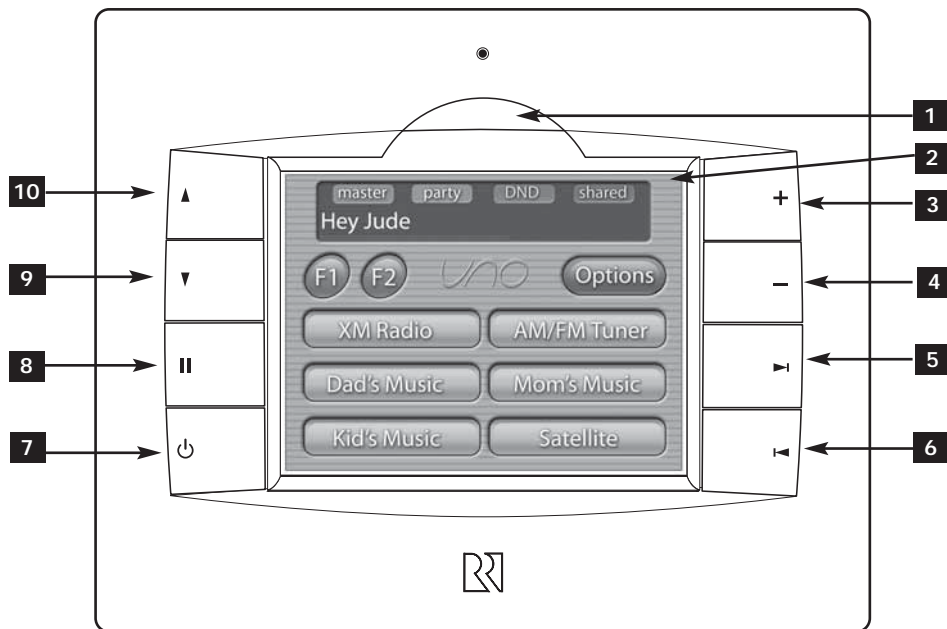

- 1** IR RECEIVER - Receives IR signals and passes them to the controller and source equipment. Also used when operating the touchscreen by using the SRC2 remote
- 2** TOUCHSCREEN - Full color resistive touchscreen with multi-sound feedback. Screen can be programmed to go blank after a period of inactivity. Touching the screen anywhere reactivates it.
- 3** PLUS - Adjust setting for selected source
- 4** MINUS - Adjust setting for selected source
- 5** NEXT - Go to next selection for selected source
- 6** PREVIOUS - Go to previous selection for selected source
- 7** POWER - Turn room power on/off. Press and hold for system all on/all off
- 8** PAUSE - Pause/mute for selected source
- 9** VOLUME DOWN - Adjust volume down for room controlled by touchscreen
- 10** VOLUME UP - Adjust volume up for room controlled by touchscreen

USER COMPONENT GUIDE

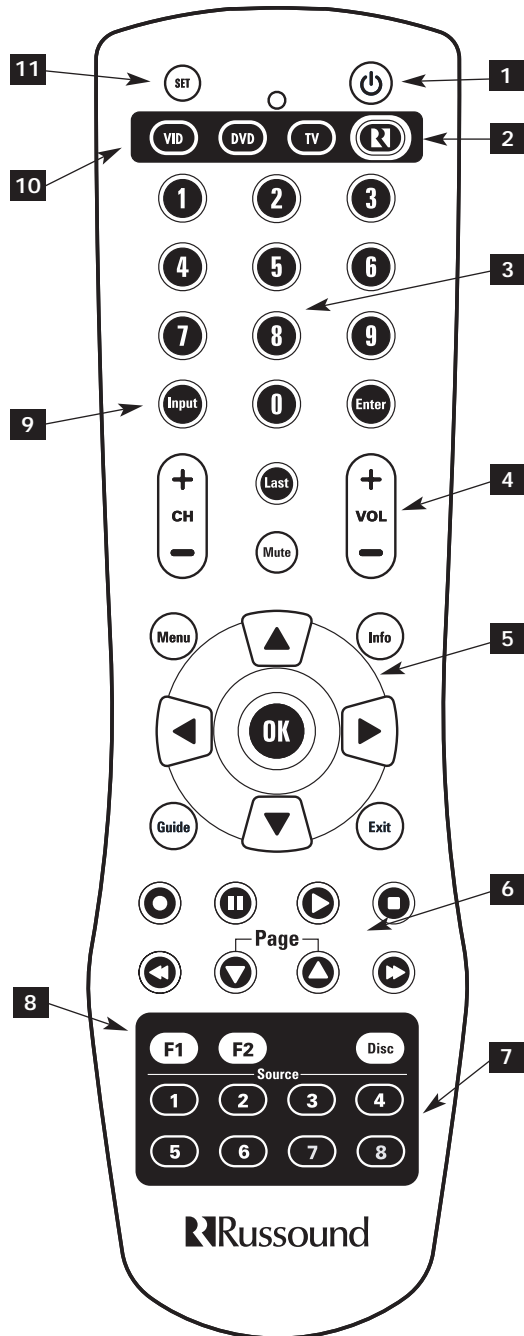

SRC2 Remote Control





- 1** POWER - Turns room or Local Source on and off.
- 2** RUSSOUND DEVICE BUTTON - Used for SRC2 control of zone keypad.
- 3** NUMBER BUTTONS - Buttons (0-9) for direct selection of channels or discs.
- 4** VOLUME UP/DOWN - Raises and lowers the volume for the room you are in, or for the selected Local Device.
- 5** CURSOR KEYS - Issues IR commands for source equipment, allowing movement through menus and program screens.
- 6** COMMAND KEYS - Controls the selected device (e.g., VCR, DVD, or CD player) with these buttons.
- 7** SOURCE - Directly select sources connected to the Russound controller while in the Russound mode.
- 8** F1 AND F2 BUTTONS - Selects and saves Favorite 1 or Favorite 2 preset selections.
- 9** INPUT - Scrolls through sources while in the Russound mode, or switches inputs on selected Local Source.
- 10** LOCAL DEVICE BUTTONS - Selects Local Source to be controlled by SRC2.
- 11** SETUP - Use for programming SRC2 using the built-in library or by learning-in codes.

UNO-S1 Keypad Button Function

Room On/Off

Press and release  to turn on the UNO System Keypad. This also turns on the corresponding CAM6.6's room, and any presets previously assigned will be activated, including settings for bass, volume, last source selected, etc. Press and release  to turn off the UNO System Keypad. This will also put the corresponding CAM6.6's room into a standby state.



System All On/Off

An "All On" command is issued by pressing  and holding for 3 seconds, from a keypad that has been turned on. An "All Off" command can be issued to all rooms by pressing and holding  after the room has been turned off.

System On Indicator

When the room is off, but the system is on in another room,  is illuminated by a green backlight and the "SYS ON" icon remains visible.

Source Select Button



 scrolls through the six audio source inputs. To change sources, press and release . As the sources are sequentially selected, each source's name appears on the keypad LCD panel. When a source is selected in more than one room, the "SHARED" icon will appear on all UNO Keypads using that source.  is also

used to enter the User Menu with a press and hold action. (See next page for User Menu)

Volume Up/Down Buttons

The room's audio output is adjusted using .

Command Keys

The command keys   allow control of the selected source at the UNO Keypad. The command keys are activated with a press and release, or press and hold to access secondary functions.





USER

USER MENU SETTINGS

UNO-S1 User Menu Operation

The User Menu allows the user to adjust the audio properties and control functions of a particular room.







To enter or exit the User Menu, press and hold  during normal operation. The following keys are used to navigate and make changes while using the User Menu:

-  Press and hold to adjust feature setting (increment)
-  Press and hold to adjust feature setting (decrement)
-  Go to next feature.
-  Go to previous feature.
-  View current feature setting.

UNO-S1 User Menu

Note: When within the UNO-S1 User Menu, if no keys are pressed, the display will revert back to its runtime display.

The following features make up the User Menu:

Bass  Treb  Loud  Bal  OnVol 
Bkgnd  DND  Party 

Feature and Setting:

- 1. Bass** -10 < Bass:Flat > +10
- 2. Treb (Treble)** -10 < Treble:Flat > +10
- 3. Loud (Loudness)** (more bass, fuller sound)
On or Off
- 4. Bal (Balance)** Left 10 < Center > Right 10
- 5. OnVol (Turn on Volume)** (default room volume level) 0 to 100 (in steps of 2)
- 6. Bkgnd (Background Color)** (keypad background light) Amber or Green or Off
- 7. DND (Do Not Disturb)** - On or Off (default)

Do Not Disturb means do not disturb this room or selected source. This stops pages from being sent to this room, stops an "All Off," "All On" or

Party Mode command from affecting this room. When another UNO Systems Keypad selects the same source, a DND message will scroll on the LCD panel, alerting the user the source is in Do Not Disturb mode.



8. Party (Party Mode) - Master or Off

When in "PARTY MODE" the system is primarily controlled by a "MASTER" Keypad. Party Mode links all rooms to the same source which is selected by the Master Keypad room. Any keypad in the system can become a Master Keypad (if enabled) but only one Master Keypad may exist at a time in Party Mode. Selecting Master Keypad mode from another keypad will transfer Master Keypad control to that room and release it from the first. When the source selected in the Master Keypad room is changed then the source for all rooms changes as well. The keypad will scroll a PARTY message on the LCD panel. It will scroll a MASTR message in lieu of PARTY if Master is enabled.



Volume level changes at the Master Keypad will be reflected in all rooms in Party Mode. Non-Master rooms in Party Mode can temporarily override Master Keypad volume level adjustments for their particular room preference. Master Keypad will not change Bass, Treble, or Loudness adjustments for any other rooms other than the Master Keypad room. Every other keypad will still operate its respective bass, treble, balance and loudness adjustments for that room.

UNO-S2 Keypad Button Function

Room On/Off

Press and release  to turn on the UNO System Keypad. This also turns on the corresponding CAM6.6's room, and any presets previously assigned will be activated, including settings for bass, volume, last source selected, etc. Press and release  to turn off the UNO System Keypad. This will also put the corresponding CAM6.6's room into a standby state.



System All On/Off

An "All On" command is issued by pressing  and holding for 3 seconds, after an initial room has been turned on. An "All Off" command can be issued to all rooms by pressing and holding  after the room has been turned off.

System On Indicator

When the room is off, but the system is on in another room,  is illuminated by a green backlight and the "SYS ON" icon remains visible.

Source Select Button







 scrolls through the six audio source inputs. To change sources, press and release . As the sources are sequentially selected, each source's name appears on the keypad LCD panel. When a source is selected in more than one room, the "SHARED" icon will appear on all UNO Keypads using that source.  is also

used to enter the User Menu with a press and hold action. (See next page for User Menu)

Volume Up/Down Buttons

The room's audio output is adjusted using .

F1 and F2 Buttons

The  and  buttons are user favorite presets. These presets can be selected at any time to recall source selection, volume, and favorite channel, disk, etc. To store a favorite preset: first, adjust the room settings and select a source to be stored. Next, press and hold the desired  or  button until SAVED is displayed on the LCD panel. Now a press and release of the button will recall the favorite preset. To set a favorite numbered disk or channel, use  or  to select a disk or channel (e.g., channel 45). Wait for the keypad to show the source name, then press and hold the F1 or F2 within 15 seconds of setting the numeric selection to save the setting.

Command Keys

The command keys allow control of the selected source at the UNO Keypad. The command keys are activated with a press and release, or press and hold to access secondary functions.





USER





USER MENU SETTINGS

UNO-S2 User Menu Operation

The User Menu allows the user to adjust the audio properties and control functions of a particular room.









The following keys are used to navigate and make changes while using the User Menu:

To enter the User Menu, press and hold  during normal operation. To exit the User Menu, press and release .

-  Adjust feature setting (increment).
-  Adjust feature setting (decrement).
-  Go to next feature.
-  Go to previous feature.
-  View current feature setting.

Note: When within the UNO-S2 User Menu, if no keys are pressed, the display will revert back to its runtime display.

The following features make up the User Menu:

BASS  TREBLE  LOUDNESS  BALANCE
 TURN ON VOL  BG COLOR  DO NOT
DSTRB  PARTY MODE 

Feature and Setting:

- 1. BASS**
-10 < Bass:Flat > +10
- 2. TREBLE**
-10 < Treble:Flat > +10
- 3. LOUDNESS** (more bass, fuller sound)
On or Off
- 4. BALANCE**
Left -10 < Center > Right +10
- 5. TURN ON VOL** (default room volume level)
0 to 100
- 6. BG COLOR** (keypad background light)
Amber or Green or Off

7. DO NOT DSTRB - On or Off (default)

Do Not Disturb means do not disturb this room or selected source. This stops pages from being sent to this room, stops an "All Off," "All On" or Party Mode command from affecting this room.

When another UNO Systems Keypad selects the same source, a DND icon will appear alerting the user the source is in Do Not Disturb mode.

8. PARTY MODE - Master (Enable) or Off (Disable)

When in "PARTY MODE" the system is primarily controlled by a "MASTER" keypad. Party Mode links all rooms to the same source which is selected by the Master Keypad room. Any keypad in the system can become a Master keypad (if enabled) but only one Master Keypad may exist at a time in Party Mode. Selecting Master keypad mode from another keypad will transfer Master keypad control to that room and release it from the first. When the source selected in the Master keypad room is changed then the source for all rooms changes as well.

Volume level changes at the Master Keypad will be reflected in all rooms in Party Mode. Non-Master rooms in Party Mode can temporarily override Master Keypad volume level adjustments for their particular room preference. F1 and F2 favorite presets selected from the Master Keypad will be enabled in all rooms in Party Mode. Master Keypad will not change Bass, Treble, or Loudness adjustments for any other rooms other than the Master Keypad room. Every other keypad will still operate its respective bass, treble, balance and loudness adjustments for that room.

UNO-TS2 Touchscreen Button Function

Room On/Off

To turn on the room and the touchscreen, touch the UNO-TS2 screen anywhere, or press and release the power button. Any presets previously assigned will be activated, including settings for bass, volume, last source selected, etc. Press and release the power button to turn off the touchscreen, and to put the room into a standby state.

System All On/Off

An "All On" command is issued by pressing the power button and holding for 3 seconds, after an initial room has been turned on. An "All Off" command can be issued to all rooms by pressing and holding the power button after the room has been turned off.

System On Indicator

When the room is off, but the system is on in another room, the power button is illuminated by a red backlight.

Volume Up/Down Buttons

The room's audio output is adjusted using the volume up/down hard buttons on the side of the touchscreen.

F1 and F2 Buttons

The F1 and F2 buttons are user favorite presets. These presets can be selected at any time to recall source selection, volume, and favorite channel, disc, etc. To store a favorite preset: first, adjust the room settings and select a source to be stored. Next, press and hold either F1 or F2 until "SAVED" is displayed on the LCD panel. Now a press and release of the button will recall the favorite preset. To set a favorite numbered disc or channel, use Plus or Minus to select a disc or channel from its source screen. Wait for the touchscreen to show the source name, then press and hold F1 or F2 within 15 seconds of setting the numeric selection.

Source Select Button

The six buttons in the middle of the touchscreen's home page show the six assigned names of the sources. To select a source, press the button assigned to that source. To change sources, return to the home screen and press another source button. As the sources are selected, each source's name appears on the touchscreen's LCD panel. When a source is selected in more than one room, the "shared" icon will be lit on all UNO Keypads using that source.

Source Control Screens

As each source button is pressed, a different screen appears that is customized to the source. These source screens come in "sets" which may have more than one screen per source that provide source information and selection options. In addition, the hard buttons on the right side of the touchscreen have secondary functions that are indicated with text on the specific source screens.



UNO-TS2 Home Screen

USER

USER MENU SETTINGS

UNO-TS2 - Setting Preferences

The Options button on the home screen brings up room setting options and screen adjustments. (For more detailed information, consult the UNO-TS2 Instruction Manual)

Features

Turn On Volume - This sets the room's default volume when the room is turned on.

Party Mode - When in "PARTY MODE" the system is primarily controlled by a "MASTER" Keypad. Party Mode links all rooms to the same source which is selected by the Master Keypad room. Any keypad in the system can become a Master Keypad (if enabled) but only one Master Keypad may exist at a time in Party Mode.

Do Not Disturb - Do Not Disturb means do not disturb this room and selected source. This stops an "All Off" or Party Mode command from affecting this room. When another UNO Systems Keypad selects the same source, a DND icon will appear alerting the user the source is in Do Not Disturb mode.

Sound Control

Bass - Adjust the bass level for the room

Balance - Adjust the left-to-right speaker balance for the room

Treble - Adjust the treble for the room

Loudness - Turn loudness (more bass, fuller sound at "low" volumes) on or off for the room. A checkmark appears to indicate "Loudness" activation.



Options screen



Features screen



Sound Control screen





UNO-S1 Keypad Control

UNO-S1 Keypad Control of Tuner

Selecting the tuner

On the UNO-S1 keypad, press  to select the AM/FM tuner by choosing the tuner's pre-assigned source number (1).

Selecting the desired frequency

Press and hold  or  to activate manual tuning. Once active, press  or  to scroll

through frequencies. The frequency will scroll twice on the keypad then stop and display the station's first 5 characters.

Setting a Memory Preset

The SRC2 remote control is used to set memory presets for all six banks. See page 22 for details.

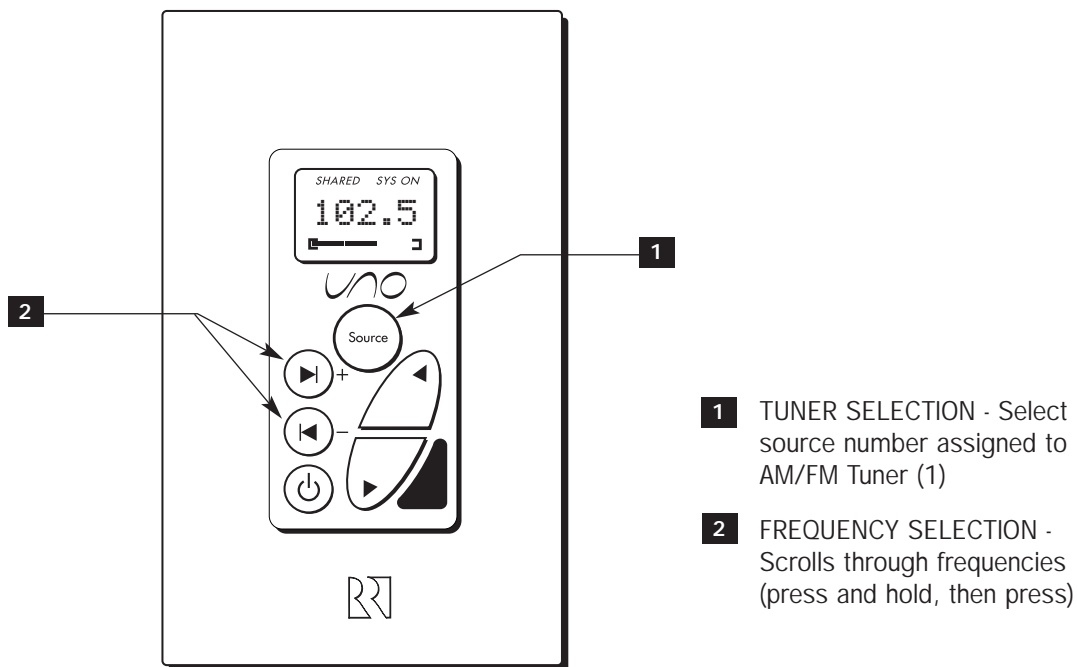

- 1** TUNER SELECTION - Select source number assigned to AM/FM Tuner (1)
- 2** FREQUENCY SELECTION - Scrolls through frequencies (press and hold, then press)

USER

INTERNAL SOURCE - AM/FM TUNER

UNO-S2 Keypad Control

UNO-S2 Keypad Control of Tuner





Selecting the tuner

On the UNO-S2 keypad, press  to select the AM/FM tuner by choosing the tuner's preassigned source number (1).



Selecting the desired band

Push  to toggle between AM band and FM band reception.



Selecting the desired frequency

Use  and  for manual tuning. The frequency will appear on the keypad and the active tuner. To move quickly through the stations, press and hold either  or  for more than 1.5 seconds.

Frequency Seek

A press on  will seek the next higher tuneable station. If a tuneable station is not found, end the SEEK function by pressing  again.

Frequency Scan



To scan, press and hold then release . The tuner scans through tuned stations with a 5-second preview before moving to the next station. To end scanning, press  again.

Selecting a Bank

The AM/FM tuner can store up to 36 favorites, or memory presets. These are stored in groups

of six called banks, and there are six banks.



Each preset and each bank can be given a custom name of your choice.

To select a bank, press and hold  for bank up or  for bank down. The bank's name will be temporarily displayed on the UNO-S2. Banks and memory presets are custom-named in the Peripheral Setup Menu (see Installation Menu section of this manual).

Setting a Memory Preset

The SRC2 remote control is used to set memory presets for all six banks. See page 22 for details.

Recalling a Memory Preset

Press  and  to scroll through the memory presets for the selected bank. This procedure will step through all of the presets in the current bank, then loop back to start at the first one. Only configured presets will be displayed.

Mute

Press  to mute/unmute the tuner audio output.

UNO-S2 Keypad Control

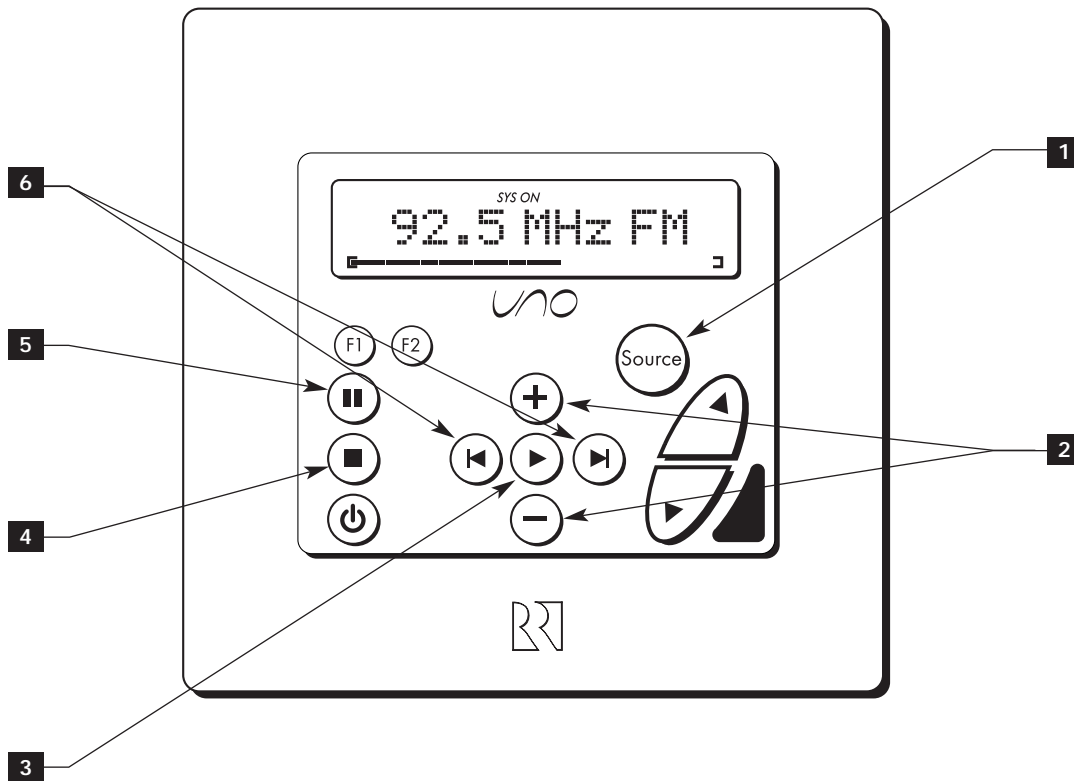

1 TUNER SELECTION - Select source number assigned to AM/FM TUNER (1)

2 TUNE UP/DOWN - Used for manual station selection

3 SELECT - Selects AM or FM band

4 SEEK - (press) Seeks next higher tuned station

4 SCAN - (press and hold) Scans through tuned stations with 5-second preview before next station

5 MUTE - Mutes/unmutes tuner audio output

6 BANK SELECT - (press and hold) Used for bank selection

6 MEM UP/DOWN - (press) Scrolls through memory preset stations

USER

INTERNAL SOURCE - AM/FM TUNER

UNO-TS2 Touchscreen Control

UNO-TS2 Control of Tuner

Selecting the tuner

On the UNO-TS2 touchscreen home page, press the named source button to select the AM/FM tuner.

Selecting a Bank

From the "1 of 3" tuner screen, select the bank by scrolling using the forward/back arrow next to the bank name. The bank name shows in the window. There are six available banks that store up to six presets each. Banks and memory presets are custom-named in the Peripheral Setup Menu (see Installation Menu section of this manual).

Setting a Memory Preset

From the "1 of 3" tuner screen, press the "tune" up/down hard button functions to select the desired station. Press and hold one of the six buttons in the middle of the screen to save the preset. When you hear the harp sound from the touchscreen, the preset is saved. The preset name then appears on the buttons. These may be custom names or frequencies.

New presets can be saved over existing presets using the same method.

Note: *If the UNO-TS2 is powered on before the Russound Tuner is turned on, existing preset names may not appear until after the tuner's boot up procedure is complete (less than a minute).*

Recalling a Memory Preset

From the "1 of 3" tuner screen, press and hold one of the six buttons in the middle of the screen to recall the preset. Only configured presets will be displayed.

Presets can also be recalled from any tuner screen by using the "memory up/down" hard button functions on the bottom right of the

screen. These will be selected from the bank that is currently selected.

Selecting the desired band

From the "2 of 3" tuner screen, press the "AM" or "FM" button to select the desired band.

Selecting the desired frequency

From the "2 of 3" tuner screen, enter the 3- or 4-digit frequency number. The "tune up/down" hard buttons can also be used to select a station.

Frequency Seek and Scan

From the "3 of 3" tuner screen, select either the "Seek" or "Scan" button. Press the button to begin the seek or scan function, then press the "Stop" button on the screen to end. The "tune up/down" hard buttons can also be used to select a station.

Local - Distant Reception

From the "3 of 3" tuner screen, the Local/Distant Reception setting changes how the tuner's antenna picks up signals. Normal operation is in Distant mode. However, in cities, antennas can pick up multipath signals when they bounce off buildings and get doubled. In these cases, the Local mode limits the noise associated with these reflected signals.

Stereo - Mono Output

From the "3 of 3" tuner screen, change the output of a radio station by choosing either Stereo or Mono.

Mute

Press the mute hard button on the outside left of the UNO-TS2 to mute the tuner when it is the selected source.

UNO-TS2 Touchscreen Control

Banks and Memory Presets

Example of Bank and Preset screen for Russound Tuner



Numeric Station/Channel Selection

Example of numeric station selection screen for Russound Tuner



AM/FM Tuner Advanced Features

Example of AM/FM tuner screen



USER

INTERNAL SOURCE - AM/FM TUNER

SRC2 Remote Control

SRC2 Control of Tuner





Selecting the tuner

To select the tuner, push  to toggle through sources and choose the source number preassigned to the AM/FM tuner (1), or use the UNO numeric source inputs at the bottom of the SRC2.







Selecting the desired band

Push  to toggle between AM/FM reception.



Selecting the desired frequency

Use the Channel  and  or  and  for manual tuning. To move quickly through the channels, press and hold the button for more than 1.5 seconds. To directly select a station, enter the three- or four-digit channel or frequency (1071 for 107.1, etc.). European regions use five-digit station frequencies.



Frequency Seek

The SEEK function is performed by pressing and releasing the Select  or  or . To seek higher frequency station press . Press  for lower frequencies. Tuning begins at the current frequency, seeks upward (or downward) and stops at the next tuned station. Pushing  or  again continues the SEEK function. Once the highest frequency is reached, the tuner continues SEEK mode at the lowest frequency.

Frequency Scan

To scan, press and hold then release . The tuner scans through tuned stations with a 5-second preview before moving to the next station. To end scanning, press  again.







Selecting a Bank

To select a bank, press and hold  for bank up or  for bank down.



Bank/Memory Presets

The AM/FM tuner has six banks of preset memory settings, and each bank holds six presets for a total of 36 possible presets.

Setting a Memory Preset

1. Select a bank - press and hold  or  until the desired bank # (1-6) appears on the keypad.
2. Select a station - tune to the desired frequency with , ,  or .
3. Press and hold a # button (1-6) until M(#) SA(ved) is displayed.

Recalling a Memory Preset

Press  and  to scroll through a loop display of all the configured memory presets for the currently selected bank.

Mute

Press the  button to mute/unmute the tuner audio output.

INTERNAL SOURCE - AM/FM TUNER

SRC2 Remote Control

RUSSOUND SELECTION - "R" must be the selected source for control of the CAM6.6 and any connected components. Select "R" before sending SRC2 remote commands.

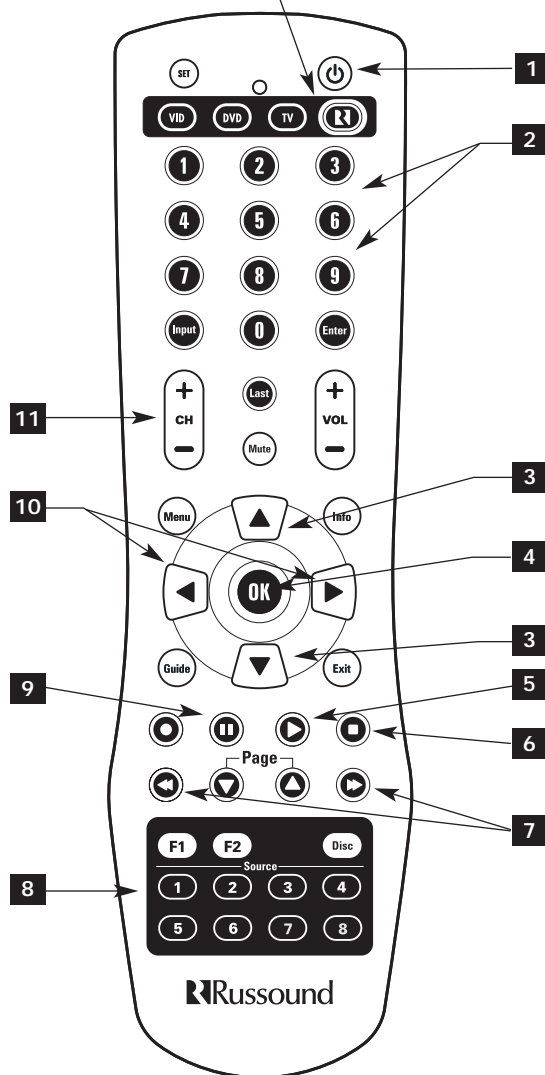

- 1** POWER - Power managed by CAM6.6
- 2** NUMERIC INPUT - (press) Number buttons for direct input of frequency
- 2** MEMORY PRESETS - (press and hold) Number buttons (1-6) for saving memory presets
- 3** TUNE UP/DOWN - Incrementally scrolls through channels or tuned stations
- 4** OK - Confirms numeric selection
- 5** PLAY - Selects AM or FM band
- 6** SCAN - (press and hold) Scans through tuned stations with 5-second preview before next station
- 6** SEEK UP/DOWN - (press) Seeks next tuned station up or down
- 7** MEM UP/DOWN - (press) Scrolls through memory presets for selected bank
- 7** BANK UP/DOWN - (press and hold) Used for bank selection
- 8** TUNER SELECTION - Select AM/FM Tuner by its assigned source number
- 9** PAUSE - Mutes/unmutes tuner audio output
- 10** SEEK UP/DOWN - Seeks next tuned station up or down
- 11** TUNE UP/DOWN - Incrementally scrolls through tuned stations



INSTALLER SECTION

Getting Started

Includes an installation overview, including tools needed and connection tips.

Component Guides

Reviews front and back panel features of the CAM6.6 controller and the UNO keypads.

Keypad Installation

Explains UNO keypad installation and wiring.

Making Connections

Details front and back panel connections of the controller and the keypads.

System Programming Overview

Outlines the programming planning process.

Installation Menu

Explains the programming menus that set up controller, keypad, source and zone operations.

Setup Menu Flow Charts

Presents the programming menus in a graphical flow chart format.

IR Device Codes

A list of controller's IR device code library for source Device Code entries.

Key Function Codes

A list of IR codes for each command type contained in the built-in library.

Source Names

A list of Source Names available for assignment.

Setup Forms

A group of information forms to complete prior to programming

Sample Configurations

Diagrams of various configurations using CAM6.6s and other components.

INSTALLER GETTING STARTED

Unpacking the System Components

- Keep the original carton and packing materials for future shipment or storage.
- Check for any visible signs of damage. If you encounter any concealed damage, consult your Russound dealer before proceeding to install the unit.
- Retain the sales receipt as it establishes the duration of the limited warranty and provides information for insurance purposes.

Tools needed for installation:

- Drill with a 1/2" x 6" drill bit
- Keyhole saw
- Flat head screwdriver (medium size)
- Phillips Screwdriver (cordless recommended)
- 110 punchdown tool (included)
- Modular RJ-45 crimper and connectors
- Pair of diagonal cutters or wire strippers
- Stud finder
- Steel wire fish tape
- Cable staples
- Single-gang electrical work boxes

System Installation Considerations

There are several factors to consider before installing the Russound CAM6.6 system:

- What are the intended listening zones?

- What system options and accessories might be required for features such as local sources, etc.?
- From where in each zone will the user prefer to control the system? Where will the keypads be located? Where will the speakers be located?
- Where will the source equipment be located? The CAM6.6 must have proper ventilation above and below for air circulation and heat dissipation. A rack-mount location may require fans and vents.

Connection Tips

- It is recommended that the CAM6.6 and the source equipment be plugged into a dedicated 20-amp circuit with an isolated ground. A power line conditioner can reduce interference problems caused by noise found in some electrical systems.
- Disconnect all live power cords before making connections to the controller.
- Verify that all connections and polarity are correct.
- Keep all power cords away from all signal cables to prevent humming from induced noise.
- Choose reliable signal cables/patch cords.
- Label all wires with room location at both ends of the wire.

CAUTION

Do not connect the controller's main power feed until all other connections have been made and verified. Live connection or removal of the keypad wiring or other wiring when the system is powered can cause communication problems in the network. Double-check terminations during each phase of the installation to prevent accidental damage. Incorrect wiring is the number one cause for non-warranty product damage.



INSTALLER COMPONENT GUIDE

CAM6.6 Controller-Rear Panel

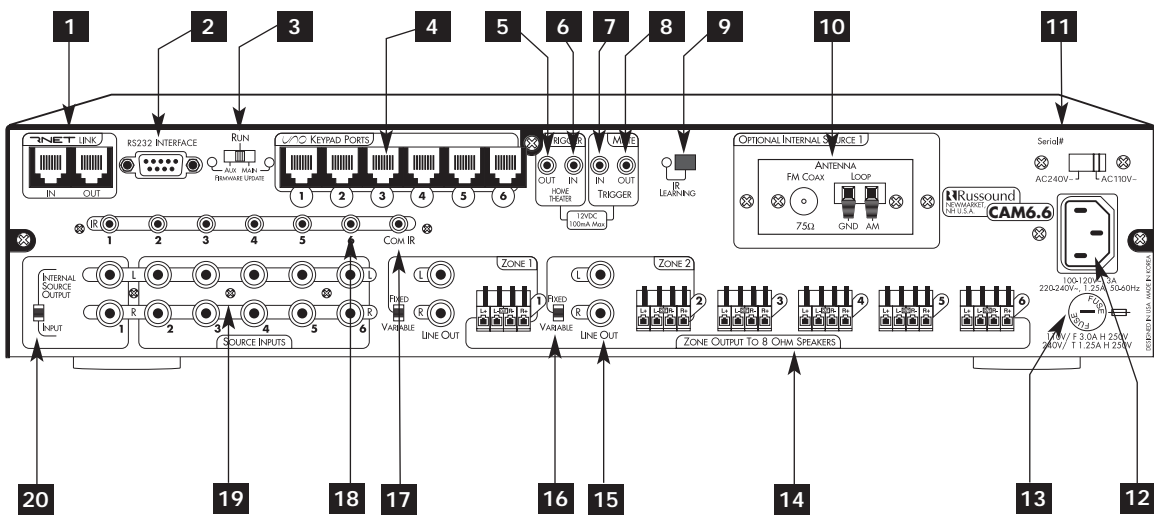

- 1** RNET LINK IN AND LINK OUT - Links multiple CAM6.6's, also links future Russound components that are RNET compatible
- 2** RS-232 INTERFACE - The RS-232 Interface allows the zones to be controlled by PC or other devices that have an RS-232 Interface. The RS-232 Interface also allows for firmware updates and programming.
- 3** AUX-MAIN RUN SWITCH - For firmware updates
- 4** UNO KEYPAD PORTS - One UNO Keypad Port for each of the six CAM6.6 Zones
- 5** 12VDC TRIGGER OUT - 12VDC 100ma Trigger Out turns on when any zone is on
- 6** HOME THEATER 12VDC TRIGGER IN - 12VDC input jack notifies the CAM6.6 that additional components are active, e.g., home theater equipment
- 7** MUTE 12VDC TRIGGER IN - Applying 12VDC to the Mute 12VDC Trigger In jack will mute audio for assigned CAM6.6 Zones
- 8** MUTE 12VDC TRIGGER OUT - Mute Trigger Out supplies 12VDC 100 mA whenever 12VDC is applied to the Mute 12VDC Trigger In
- 9** IR LEARNING WINDOW - IR receiver for learning in IR commands with confirmation LED



INSTALLER COMPONENT GUIDE

CAM6.6 Controller-Rear Panel

- 10** OPTIONAL INTERNAL SOURCE - Factory installed optional internal source, AM/FM radio module
- 11** AC 240V-AC 110V Switch - Switches A/C input voltage between 110VAC and 240VAC
- 12** AC 120/240 INPUT - Grounded 3-terminal plug detachable power cord connection for the CAM6.6
- 13** FUSE HOLDER - Holds a replaceable fuse for A/C input connection
110VAC operation - F 3A H 250V, 240VAC operation; T 1.25A H 250V
- 14** SPEAKER OUTPUTS - Connect 8 Ohm speakers for each zone with detachable color-coded modular snap connectors
- 15** AUDIO OUTPUTS - Audio line output connection
- 16** FIXED/VARIABLE SWITCH - Change line out between fixed and variable output.
- 17** COMMON IR OUTPUT - Output jack will pass all IR signals from all keypads
- 18** SOURCE IR OUTPUTS - Six source-specific IR Output jacks allow for IR control of source equipment
- 19** AUDIO INPUTS - Six sets of Audio Line Level input connections for CAM6.6 source components
- 20** OUTPUT/INPUT SWITCH - Enable Source Input 1 or enables Internal Source 1 output

INSTALLER COMPONENT GUIDE

UNO Keypad Update Port

Software Update

If a keypad update is released, it will be available online at www.russound.com through the Document Center, under RNET Systems. Before starting the update procedure, download updates to a PC and connect the correct programming cable from the PC to the OS update port on the front of the keypad.

Required Russound Cable for Programming UNO-S2, UNO-TS2

- use Programming Cable P/N 2500-121036

UNO-S1

- use Advanced Programming Cable P/N 2500-521065
(Do not put RS-232 level signals into the pins)

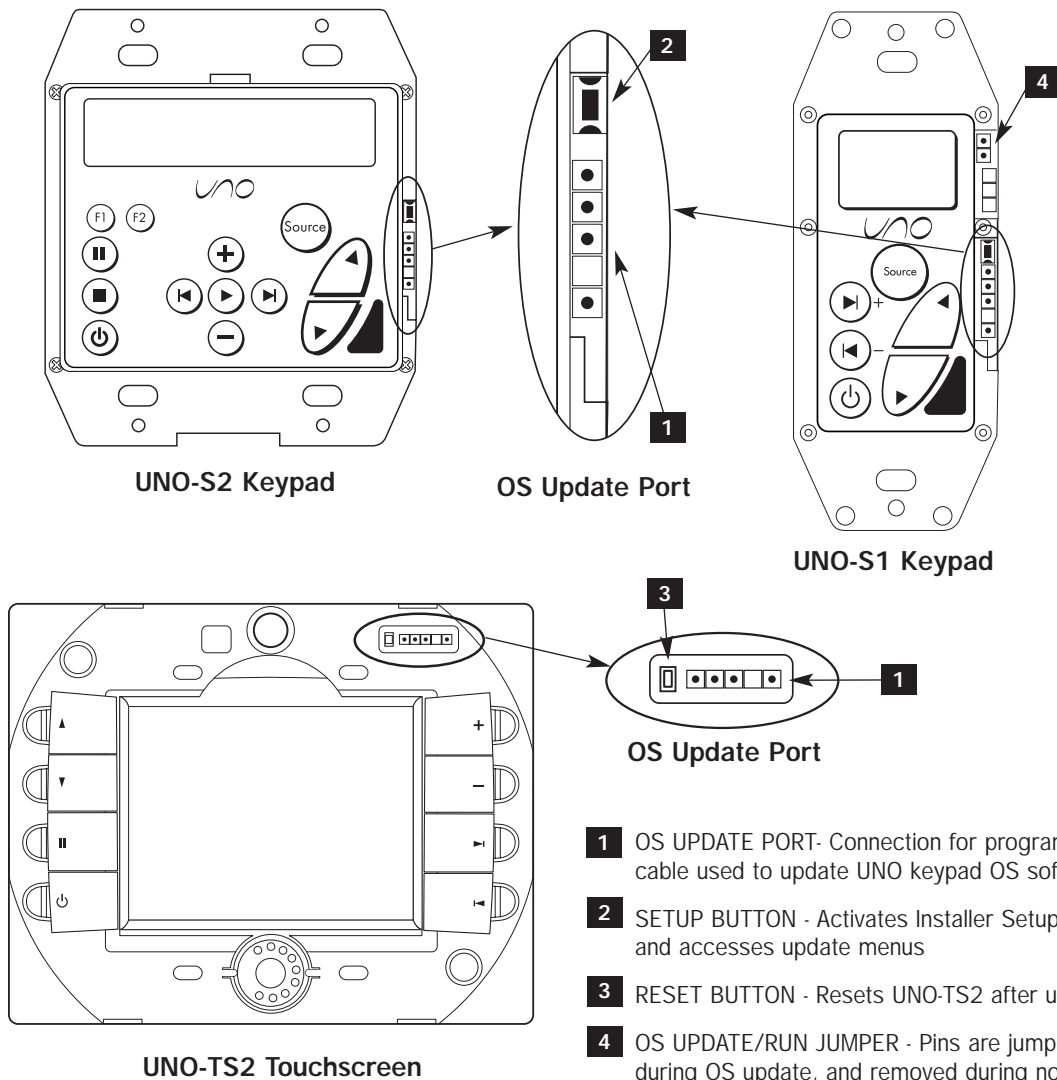

INSTALLER COMPONENT GUIDE

UNO Keypad-Rear Panel

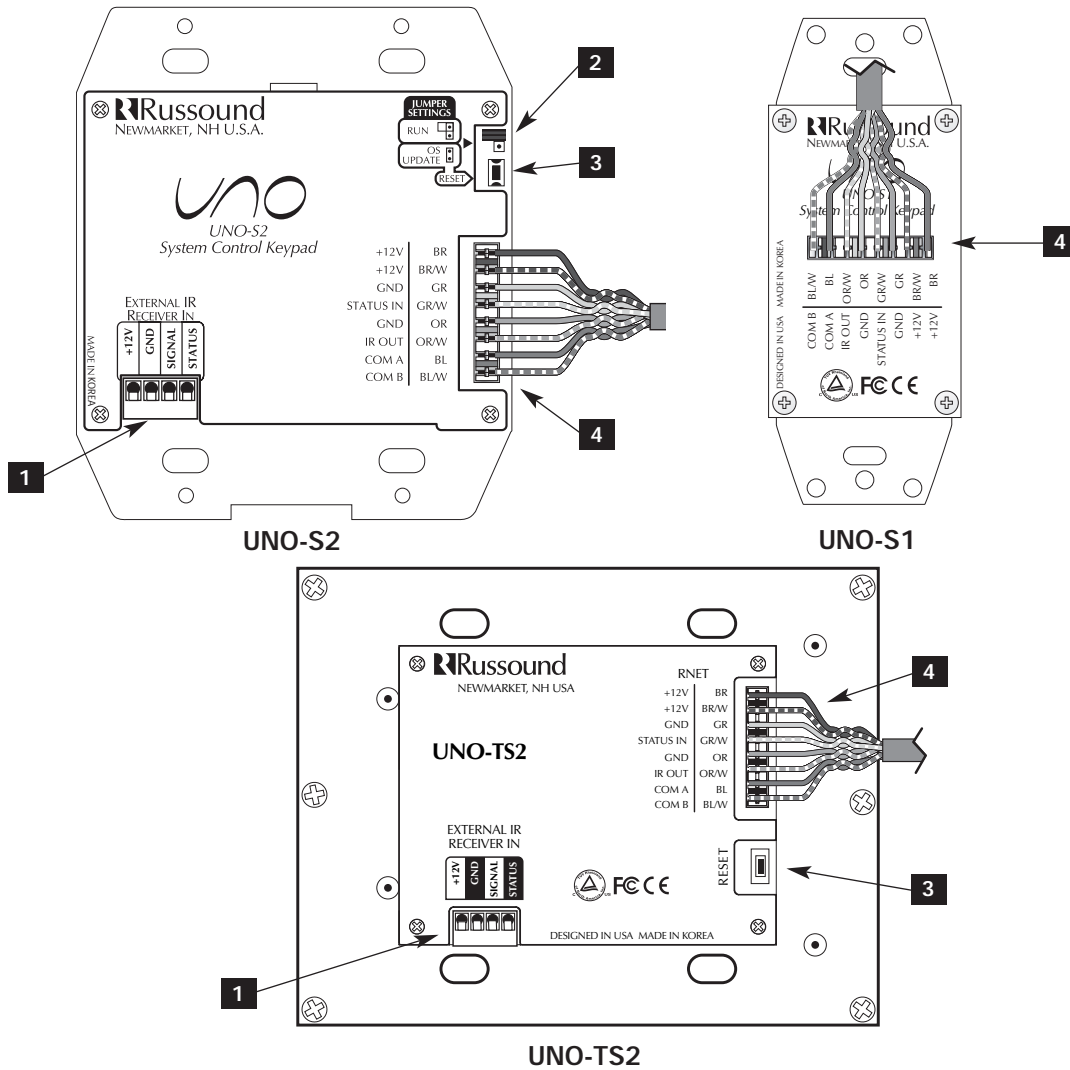

- 1** EXTERNAL IR RECEIVER IN CONNECTOR - Connection for an external IR Receiver
- 2** OS UPDATE JUMPER - Selects mode "Run" (one pin covered) or "OS Update" (two pins covered). Jumper setting must be in "Run" position for keypad operation.
- 3** RESET BUTTON - (UNO-S2) Reset whenever changing from RUN to OS update
(UNO-TS2) Reset after touchscreen firmware update
- 4** 110 PUNCHDOWN CONNECTOR - Termination for CAT-5 connection between the UNO Keypad and the CAM6.6 controller

INSTALLER WIRING INSTRUCTIONS

Wire Length

To determine the amount of CAT-5 wire required for the system installation, first decide how many keypads will be used, then determine the distance between each intended keypad location to the intended CAM6.6 location. The maximum recommended wire run length is 250 feet for each UNO keypad.

- Make sure that the entire wire path between keypads and CAM6.6 is clear and not obstructed by a floor ceiling joist, or masonry wall which can't be drilled through.
- Confirm ahead of time that you can drill an outlet hole easily and in an unobtrusive spot to connect wires with the CAM6.6.
- Label wires with keypad and room location. This simplifies CAM6.6 hook-up once the keypads and speakers are installed.

RJ-45 Connections

The CAT-5 T568A wiring standard shown below is used for the RJ-45 terminations.

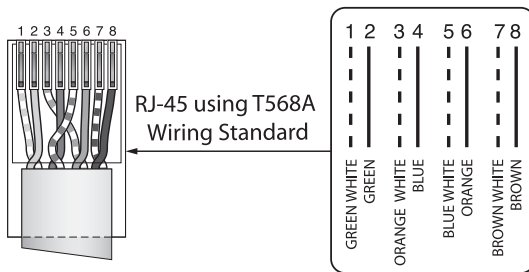

Speaker Wiring

Standard 16-gauge 4-conductor stranded speaker wire can be run up to to 125 feet; 14-gauge wire can be run up to 250 feet.

When running wire, pay particular attention to the following areas:

- Avoid locations concealing pipes, heating ducts and AC wiring in the general vicinity.
- Avoid running wires close to house electrical wiring for any distance. If you have to run them parallel, make sure to space the wires at least two feet from the AC line.

Keypad Wiring

For the UNO keypad or touchscreen, the following connections are used to terminate the CAT-5 wire to the 110 punchdown on the keypad:

<u>CAT-5 WIRE COLOR</u>	<u>TYPE</u>
Brown	+12V
Brown/White	+12V
Green	Ground
Green/White	Status In
Orange	Ground
Orange/White	IR Out
Blue	COM A
Blue/White	COM B

CAT-5 110 Punchdown Connection

The UNO keypad 110-punchdown terminal requires the use of a punchdown tool. Attach the CAT-5 cable to the 110 punchdown terminal on the UNO keypad, matching the conductor colors to the connection color guide. The keypad will not operate properly if the terminations deviate from the required connection order.

Caution

Take care when using an impact 110 punchdown tool, as this may overspread the contact points. Use of the impact tool may propel stray bits of wire and jacket into the keypad's chassis and possibly cause a short in the circuitry. Gently shake or blow air through the keypad chassis to remove stray wire before the keypad is installed into the junction box.

INSTALLER WIRING INSTRUCTIONS

IR Receiver Connection

The UNO-S2 keypad has an External IR Receiver IN terminal for connecting an external IR receiver such as the Russound SaphIR 858, 862 Eye, or 860 Phantom. Use 2 twisted pair wire with

one pair connecting GND (GROUND) and IR (SIGNAL) and the other pair connecting ST (STATUS) and V+ (+12VDC). If the wire has a shield, connect it to ground at the UNO-S2 only.

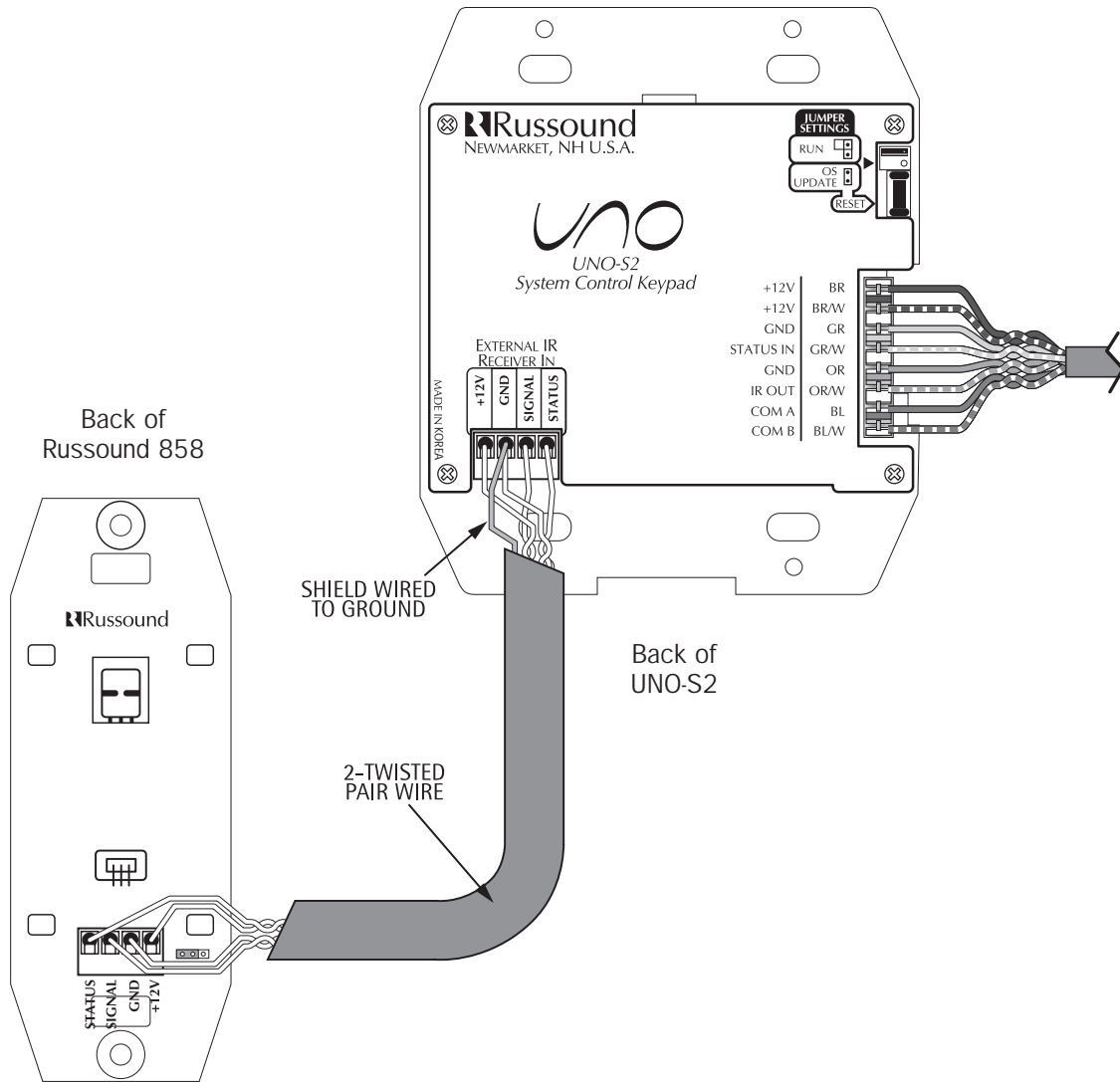

INSTALLER

UNO KEYPAD INSTALLATION

Keypad Location

The best infrared remote performance is achieved with the keypad away from any direct sunlight, plasma TV, and low voltage lighting controls. Also consider convenience when choosing a location.

Choose a place that is easily seen from the position where a person is most likely to be located.

Check whether or not you can route the wire to the location you have chosen.

Keypad Installation

An UNO keypad has three parts: the keypad, a back plate and a cover plate. To install an UNO keypad, use a UL/CSA approved plastic electrical box. Use a double-gang box for UNO-S2 and UNO-TS2. For UNO-S1, use a single-gang box.

- Route CAT-5 wire to the junction box from the CAM6.6.
- Use the supplied 110 punchdown tool to connect each wire to its corresponding color labeled on the punchdown terminal.
- Ensure jumper settings on keypads are in the run positions.
- Mount the keypad in the electrical box and attach the back plate then the cover plate.
- Repeat the steps until all keypads are installed.

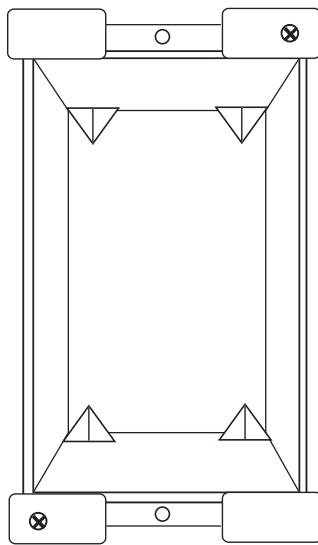

Junction Box

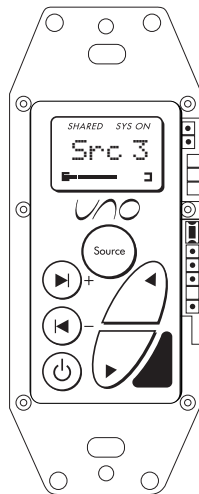

UNO-S1

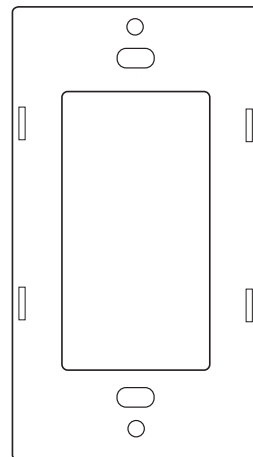

Back Plate

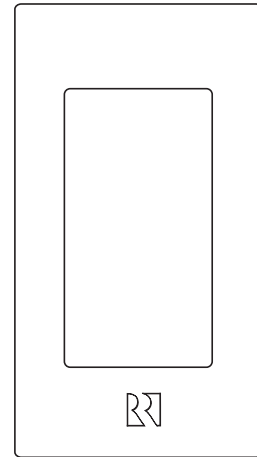

Cover Plate

INSTALLER MAKING CONNECTIONS

UNO Keypad Port Connection

The UNO System Keypad Ports are located on the back of the CAM6.6 in the top left of center. Connections made at the UNO Keypad Ports are made using CAT-5 T568A RJ-45 wire configuration. CAT-5 is color-coded for ease of installation. For a clean installation when wiring from an UNO System Keypad Port use an RJ-45 CAT-5 patch cable to connect from the keypad port to an RJ-45 Wall Plate (optional). Using the same

CAT-5 T568A RJ-45 wiring configuration, use CAT-5 from the RJ-45 Wall Plate to the keypad. If using more than one keypad on a zone, connect a SA-ZX3 UNO System Keypad Splitter (optional) directly to the UNO System Keypad Port instead of going through the wall plate. Always use the CAT-5 T568A RJ-45 wire configuration when wiring any of the UNO System Keypad Ports.

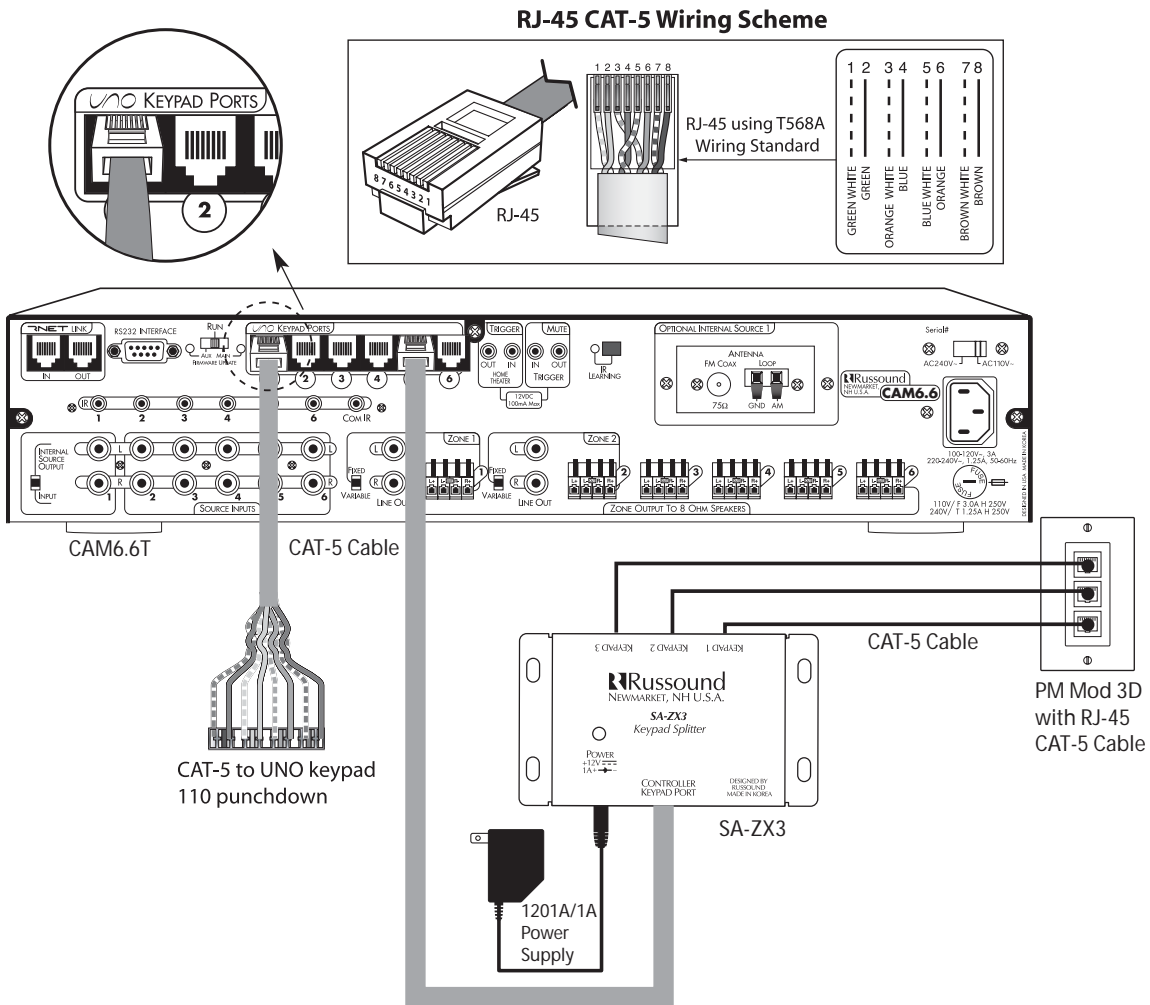

INSTALLER

MAKING CONNECTIONS

Source Audio and IR Input Connections

Source Audio Connections

The CAM6.6 supports up to six audio sources. The Source Inputs are located at the back panel. For the CAM6.6 (no internal source installed), the switch next to Source 1 input must be set to "Input." Connect each source output using quality RCA signal cables. Connect the Left and Right Audio outputs from each source to the corresponding inputs on the CAM6.6 controller. Label each cable with the name of the selected source and the Source Audio input number located on the CAM6.6.

For the CAM6.6T, the Source 1 input serves a dual purpose. If the CAM6.6 optional internal source is used, the Source 1 input is not available, and the switch next to it is set to "Internal Source Output." If you want to utilize the Source 1 inputs, set the switch to "Input" and reconfigure Source 1 in the Source Setup menu.

Note for CAM6.6T: If you hear more than one source when Source 1 is selected, recheck Source 1 wiring and switch setting.

Source IR Connections

Each source component has a designated IR port on the back of the CAM6.6. This IR port is directly above the Source Audio Input Connections.

1. Using an IR emitter (the Russound 845.1 is recommended) attach the end of the emitter with the 1/8" plug to the IR emitter port above the source input.
2. Remove the adhesive back at the other end of the emitter and attach the emitter over the source component's IR window.
3. In order to control this source component with IR, the source must be selected at the keypad receiving the command.

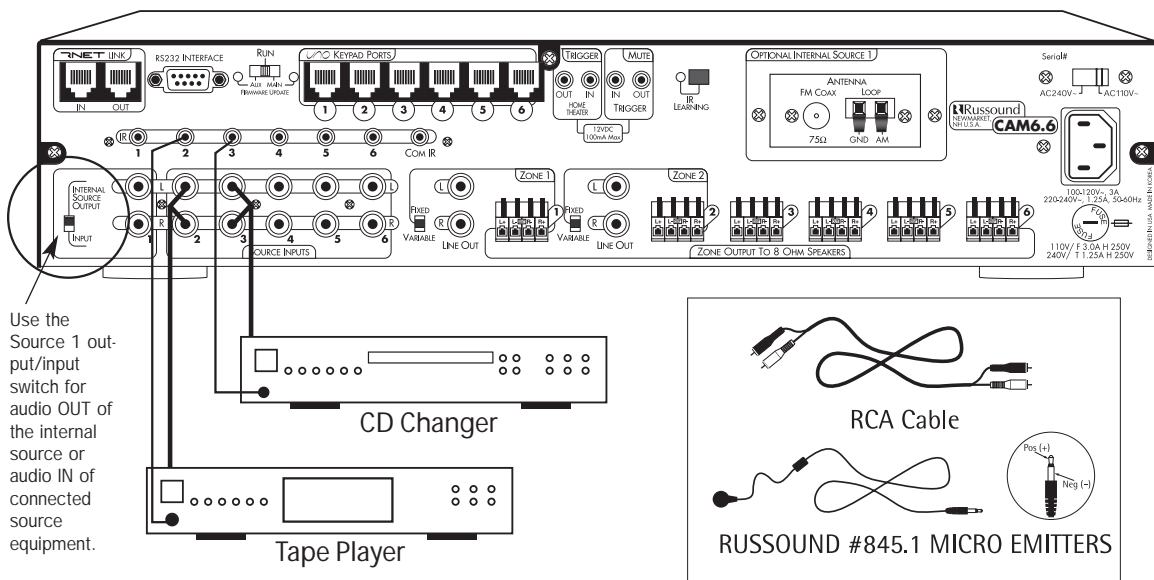

CAM6.6T with Optional Internal Source - AM/FM Tuner

INSTALLER MAKING CONNECTIONS

Common IR Connection

Common IR Connections

The Common IR jack on the rear of the CAM6.6 allows control of any source equipment without that source being selected on the keypad. The connection for the COM IR jack is made using an

IR emitter with a 1/8" plug. The Russound 845.1 single IR emitter is recommended, or use an IR connecting block such as the Russound 857 which allows multiple units to be controlled through the COM IR Port.

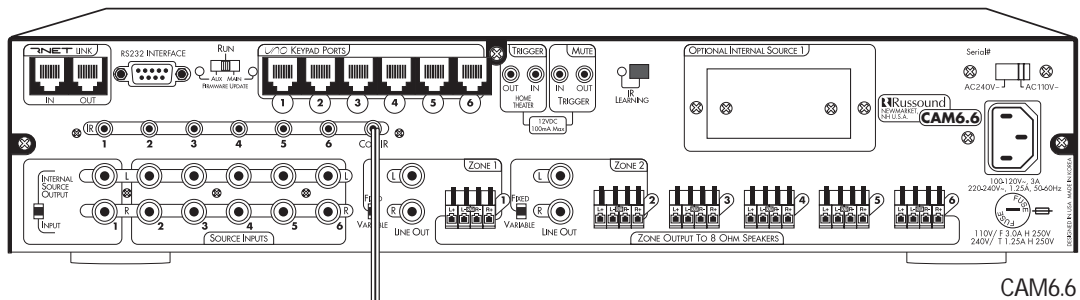
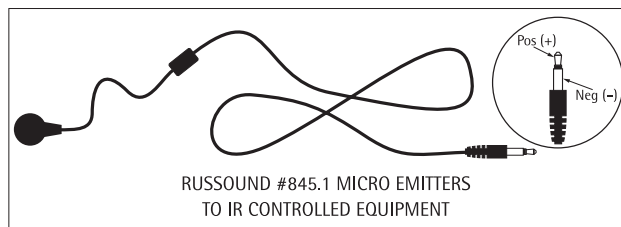

Alternate configuration
using 857 IR connecting block

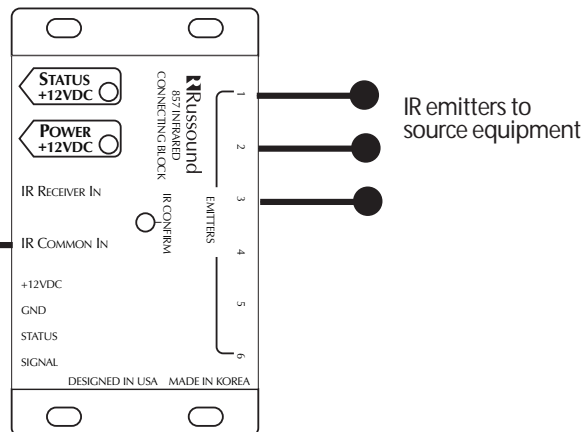

INSTALLER

MAKING CONNECTIONS

Speaker Connections

The speakers are connected to the CAM6.6 using modular snap connectors. Each of these color-coded connectors is designated for the speaker set of a particular amplified zone. To avoid confusion, connect one zone speaker set at a time starting with Zone 1, taking care to keep zone and speaker wire identities straight. Note: An 8 Ohm minimum speaker is required for each amplified output.

1. Pull the speaker wire conductors apart so they're separated for the first two inches from their ends.
2. Using a wire stripper, remove 1/4 inch of insulation from each conductor. Twist the strands in each conductor into tight spirals.
3. Remove the modular four-color connector for Zone 1. The color code is as follows:

- WHITE -- L+ (left channel positive)**
- GREEN -- L- (left channel negative)**
- BLACK -- R- (right channel negative)**
- RED -- R+ (right channel positive)**

Lift the black lever for each connection until it locks open and insert the proper speaker wire, matching channel and polarity for all four wires. Snap the lever down. Insert the modular connector into its designated output on the back of the CAM6.6.

4. Complete the same steps for the remaining zones. Label each set of speaker wires with the zone and location.

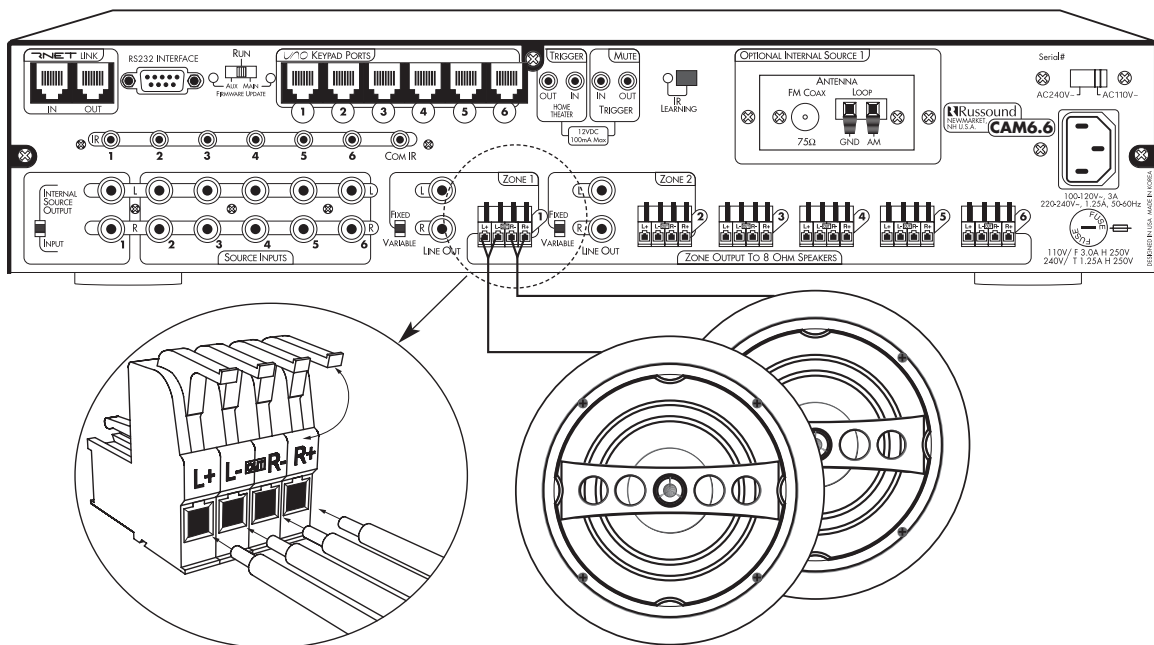

INSTALLER MAKING CONNECTIONS

Zone Fixed/Variable Audio Outputs

The CAM6.6 has two Zone Audio outputs, on Zone 1 and Zone 2. Each of these zone audio output connections features a stereo line out RCA connection plus a switch to allow for either a fixed or a variable line level output. When set to Variable, the keypad volume level affects this output. In the Fixed position, the keypad volume level will not change the output level.

The fixed or variable audio outputs can be used if additional amplification is desired (e.g., Russound R235LS two-channel amplifier). Use quality RCA signal cables to ensure a constant quality audio signal.

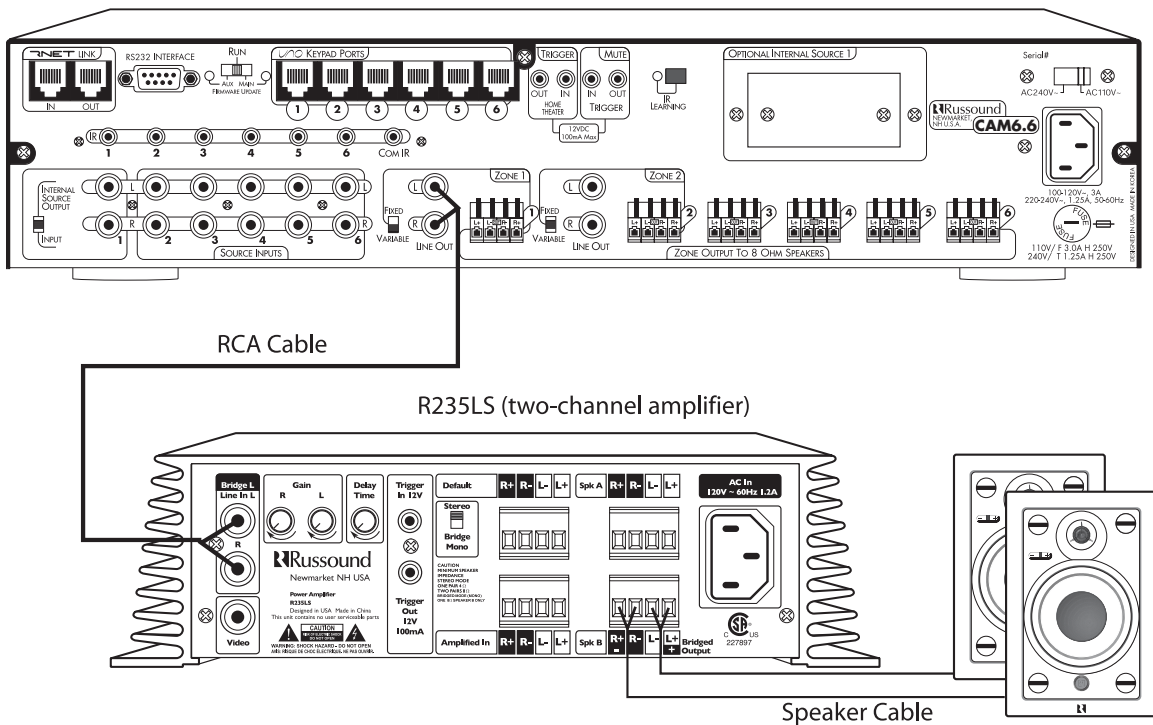

INSTALLER

MAKING CONNECTIONS

12VDC Home Theater Trigger In/Out

12VDC Home Theater Trigger In

This 12VDC Trigger input is used to control Power Management of the audio sources possibly being shared with a home theater system. When the last zone on the CAM6.6 is turned off, 12VDC presence to the trigger input will prevent the sources that are on from being turned off. The connections for the trigger are made using a two-conductor cable with 1/8" male mini-plug. The tip is positive (+) and the sleeve is negative (-).

12VDC 100mA Trigger Out

The 12VDC 100mA trigger out can be used to engage any 12VDC trigger device or component such as the Russound ACT-1 triggered outlet. The connections for the trigger out are made using a two-conductor cable with 1/8" male mini-plug jacks at each end. The tip is positive (+) and sleeve is negative (-).

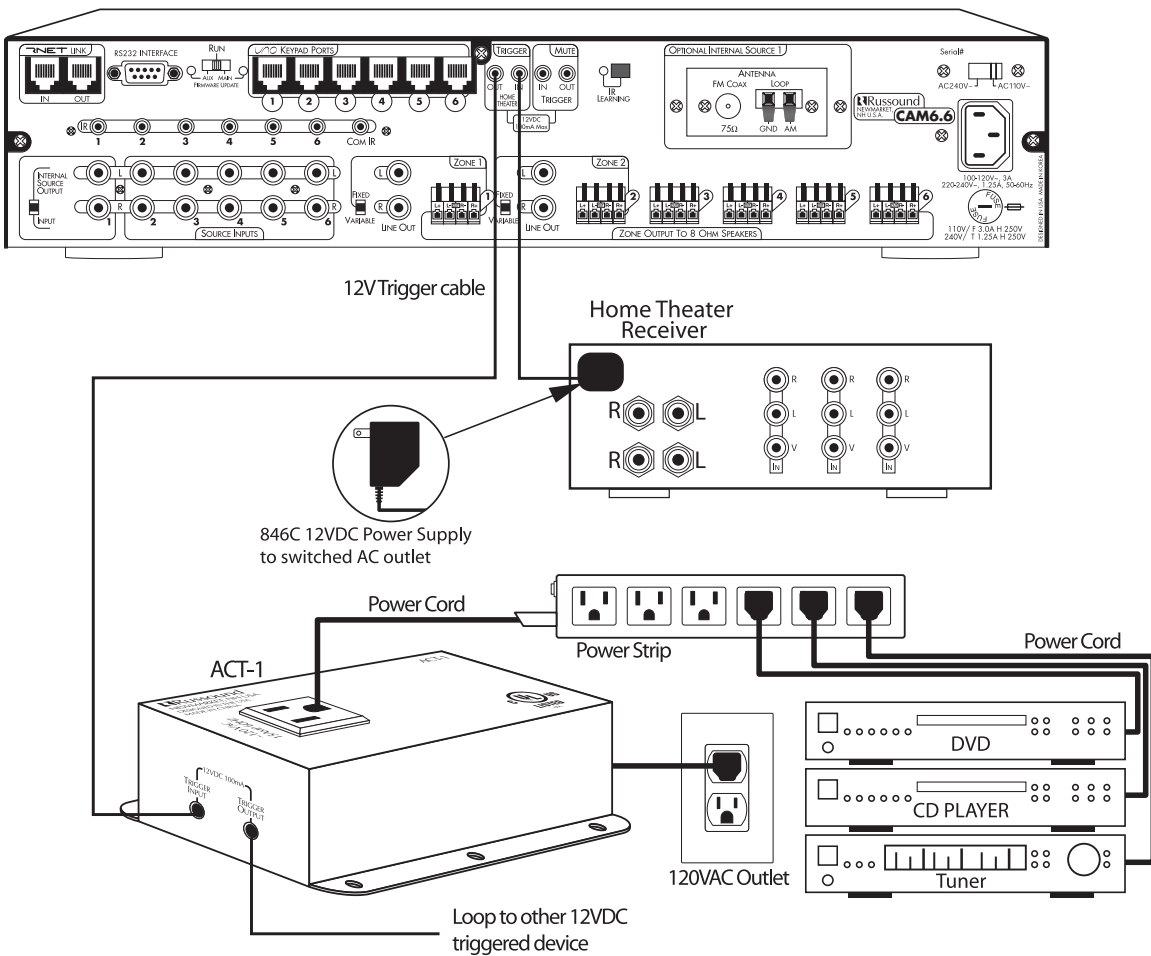

INSTALLER MAKING CONNECTIONS

12VDC Mute Trigger In/Out

12VDC Mute Trigger In

When 12VDC is applied to the Mute Trigger In, the system will fully mute any source that is connected to the Source Audio Input. The connections for the trigger are made using a two-conductor cable with 1/8" male mini-plug jacks. The tip is positive (+) and sleeve is negative (-). This allows for the connection of an external paging or muting device. The CAM6.6 can be programmed to mute audio for one or all zones as preferred when the 12VDC is applied.

12VDC Mute Trigger Out

Mute Trigger Out 12VDC output is used for triggering an external amplifier, muting device or other paging component dependent on the Mute Trigger In 12VDC. The connections for the output are made using a two-conductor cable with 1/8" male mini-plug jacks at each end. The tip is positive (+) and sleeve is negative (-). The default setting for the Mute Trigger Out provides 12VDC whenever 12VDC is applied to the Mute Trigger In.

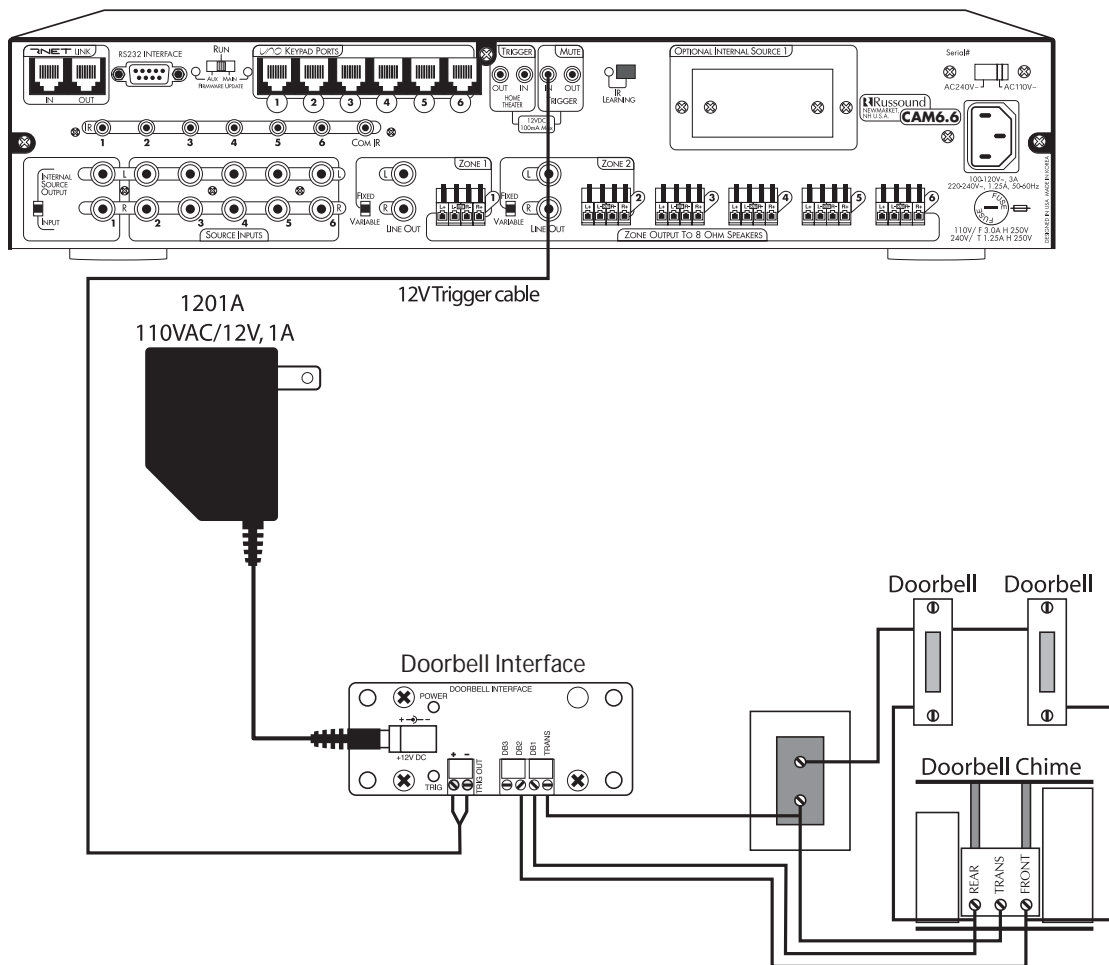

INSTALLER

MAKING CONNECTIONS

RNET Link In and Link Out

The RNET Link In and Link Out can be used to connect two to six CAM6.6 or CAV6.6 controllers. The connection is made using a CAT-5 patch cable from the Link Out of the master CAM6.6 and into the Link In of the next controller. Along with RNET data signals, the RNET Link In and Link Out jack passes the six source IR signals. These are only for source-specific IR remote repeating, not codes initiated from the controller's internal IR library. The CAT-5 patch cable should not exceed 18 inches in length to avoid potential cross-talk between the source-specific IR repeating signal lines.

The RNET Link In and Link Out is also used to connect the CAM6.6 to other Russound products with RNET.

Note: If two or more CAM6.6 or CAV6.6 controllers are connected using the RNET Link In and Link Out ports, each controller must have a unique Controller ID prior to being connected through the RNET ports. The Controller ID assignment must be performed during the Controller Setup section of the Installation menu. If using a CAM6.6T, be sure to set the Controller ID under "Peripheral Setup" to "ALL CONTROLLERS" (page 50).

Note: It is not recommended to link together two CAM6.6T controllers. If designing a CAM6.6 system with more than one tuner, use two CAM6.6 controllers and a Russound ST2 Dual Tuner (also ST2-XM, ST2-XM2, ST2S). See page

RJ-45 CAT-5 Wiring Scheme

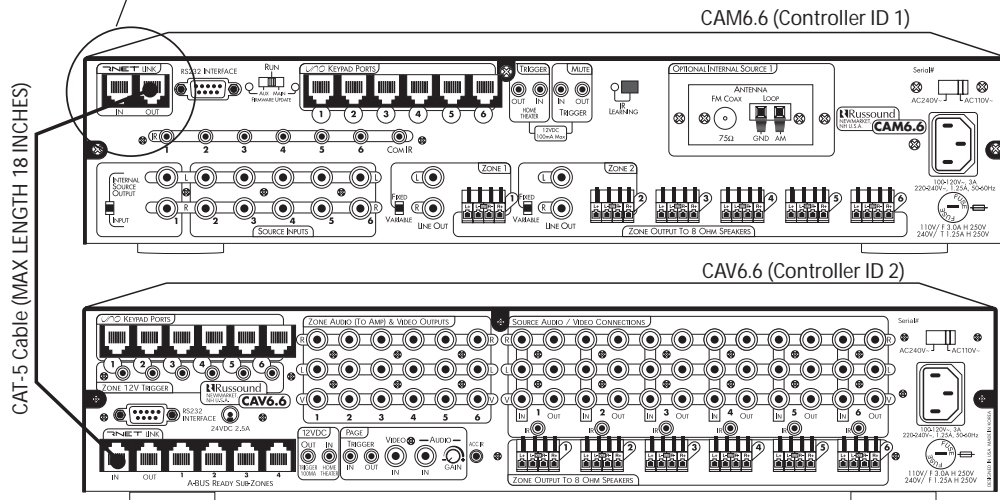
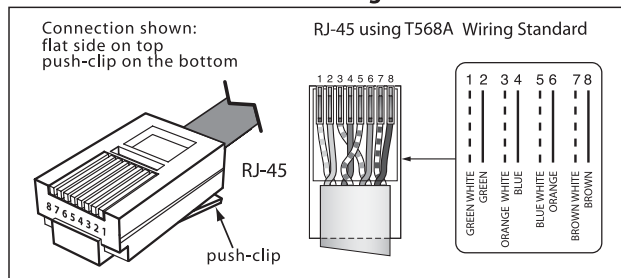

INSTALLER MAKING CONNECTIONS

RS-232 Interface

The CAM6.6 supports RS-232 communication with various third party automation systems or PC for programming of the controller.

The RS-232 com port is located on the back of the CAM6.6 and uses a DB-9 cable connection.

For RS-232 protocol and the backup PC application, go to www.russound.com, Document Center. Under RNET Systems, look under the heading for Technical Documents.

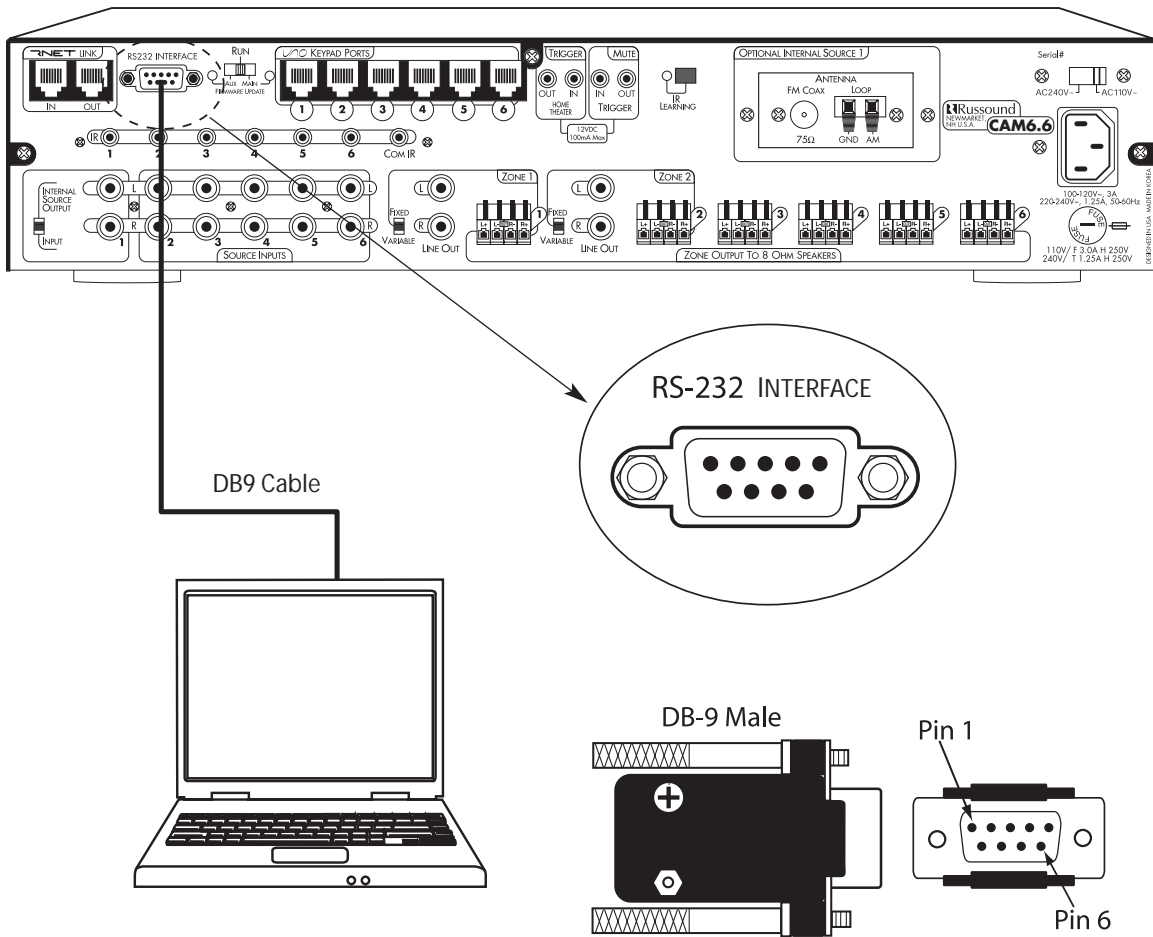

INSTALLER

MAKING CONNECTIONS

Optional Internal Source - AM/FM Tuner Antennas

AM Antenna

Connect the included loop antenna for AM reception to the Optional Internal Source panel, attaching the GND (ground) and AM ends to the appropriately marked connections.

FM Antenna

Attach the included FM antenna for FM reception to the Optional Internal Source panel by pushing the F-type quick-connect termination of the antenna onto the FM connection.

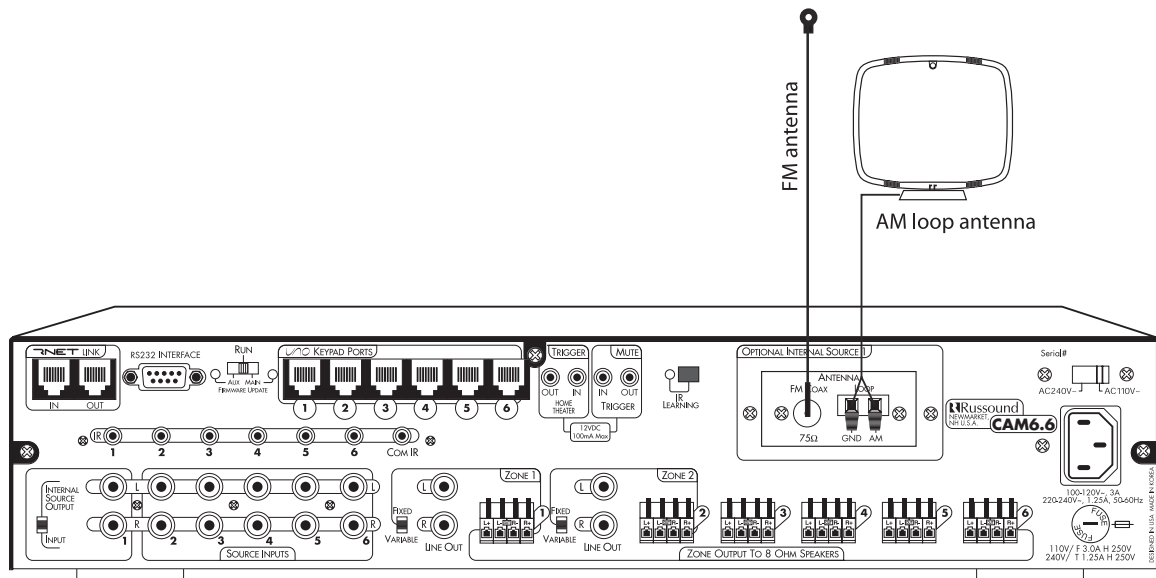

INSTALLER MAKING CONNECTIONS

Optional Internal Source - AM/FM Tuner Antennas

Connecting an Alternate Outdoor Antenna for AM/FM

The diagram below depicts a suggested installation option of an alternate outdoor FM antenna and AM antenna.

For best performance for AM reception, it is recommended to use an external outdoor or attic-mounted long wire antenna for best performance

for AM reception. Use a 75-ohm to 300-ohm balun at the AM connection on the tuner, and attach the 75-ohm coax cable to the balun.

For best performance for FM reception, it is recommended to use an external outdoor or attic-mounted antenna. Attach the desired length of 75-ohm coax cable directly to the FM connection on the tuner.

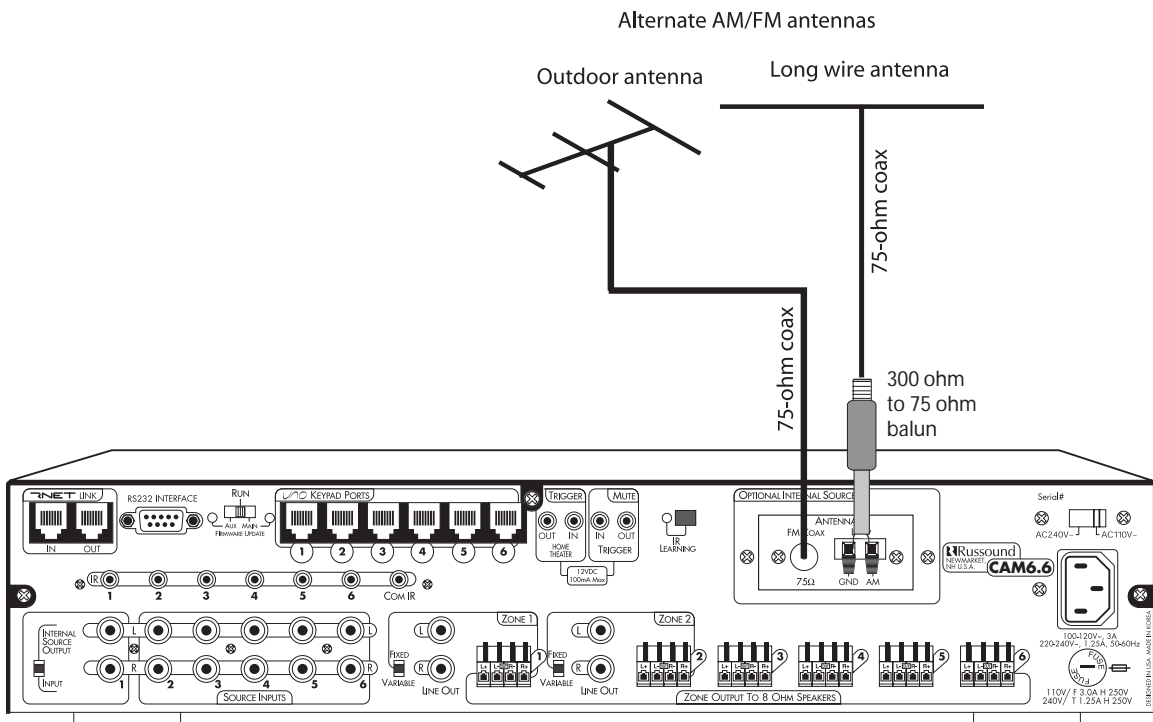

INSTALLER MAKING CONNECTIONS

Grounding Outdoor Antennas

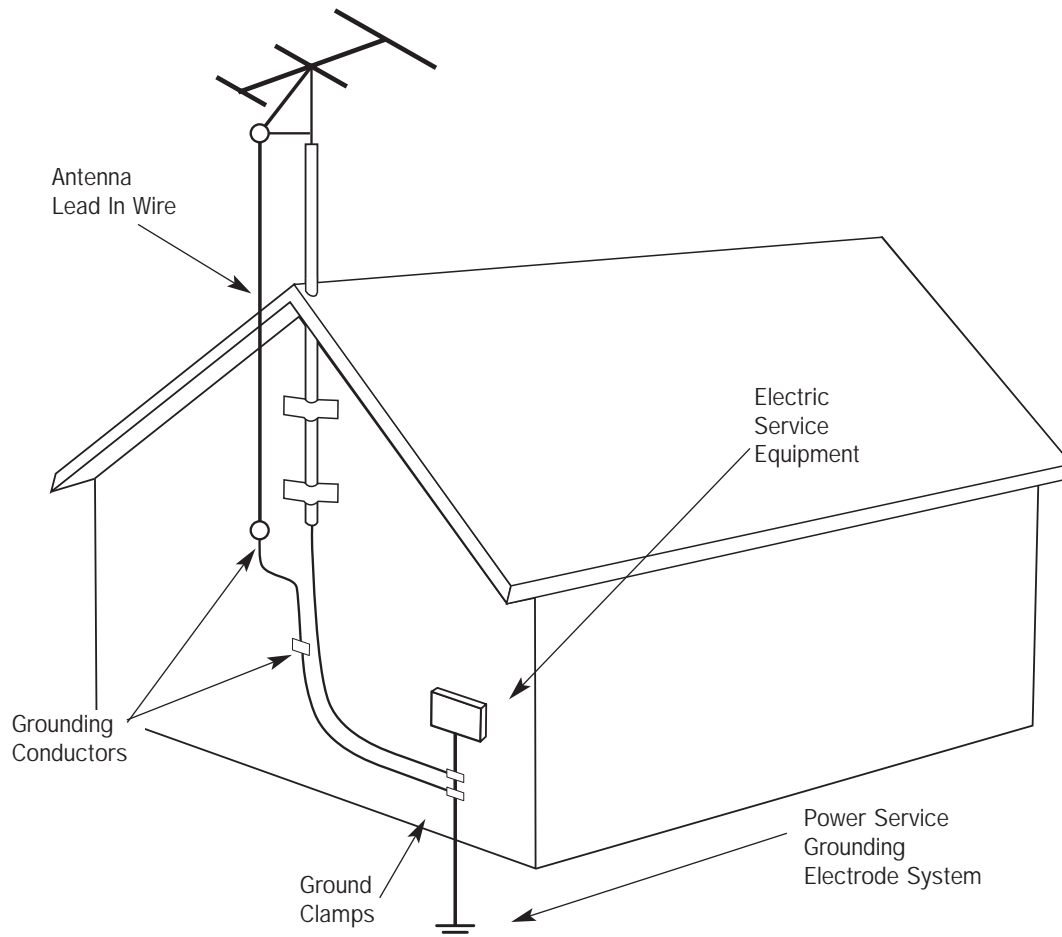

Grounding an Outdoor Antenna

If the tuner is used with an outdoor antenna, the antenna must be grounded against static charges and voltage surges. Consult the instructions that came with the antenna or contact the antenna manufacturer for proper installation instructions.

The diagram above gives a general depiction of how an outdoor antenna should be grounded. For complete guidelines on antenna grounding procedures, please consult the National Electrical Code, Section 810, ANSI/NFPA No. 70-1984.

INSTALLER INITIAL INSTALL TEST

Before proceeding to the system programming section, it's important to conduct an initial test to determine that the hardware components are working properly.

1. Connect the speaker wires from Zone #3 to the CAM6.6 Zone #3 speaker output connectors.
2. Connect an UNO keypad to Keypad Port #3 on the rear of the CAM6.6.
3. Connect a source to the Source #3 Input on the CAM6.6 using RCA Audio patch cables.
4. Plug a supplied 845.1 IR emitter into the Source #3 IR Output Jack and adhere the emitter end to the source equipment's IR window.
5. Plug in the main power cords for the CAM6.6 and the source.
6. Turn on the main power switch on the CAM6.6 and the source.
7. Manually command the source to provide audio or use the source remote control.
8. Press the power button on the UNO keypad and select Source #3.
9. To verify emitter placement, take source equipment's factory remote control and aim at a keypad (not in same room as source equipment). Source equipment should respond to IR command.

Congratulations – you should now hear the source through the speakers in Zone #3.

If there is no sound, follow these diagnostic steps:

1. Check the source to see that it is operating properly.
2. Check the RCA Audio cable connections from the source to the Source #3 Input on the CAM6.6.
3. Check the speaker connections and verify that they are correct and are connected to the Zone #3 speaker outputs.
4. Check to see that the keypad is connected to the Zone #3 Keypad Port and verify the CAT-5 is properly terminated at both ends.

If none of these steps produce successful results, call Russound Tech Support for further assistance.

INSTALLER

SYSTEM PROGRAMMING OVERVIEW

This manual includes items that are designed to assist in the programming process.

Forms (Pages 106-108)

Three blank reproducible forms are included as planning tools when determining sources, settings and zone preferences. The Source and Zone Information forms and the Macro Editor form should be completed before programming and referred to during the installation menu process. This speeds up programming time and reduces missed or incorrect entries. These forms also serve as system reference documents if future troubleshooting is needed.

IR Device Codes (Pages 78-81)

This list of command type IR device codes reflects the built-in IR codes in the CAM6.6 library. During programming, these codes will be entered for each source at the "Device Code" prompt. If a code is not listed for a source, the Learn IR procedure is available to learn in and centrally store IR codes. *(Note: Device codes for Phono, DAT and Tape are Learned Only)*

Key Functions (Pages 82-103)

This list of key functions identifies what IR codes are supported for each command type (source) by the built-in library. "Learned Only" indicates that this function is not supported and must be learned into the CAM6.6. This list of key functions reflects the different available key functions associated with what you see on the LCD panel when performing the Key Configuration procedure in the Installation Menu. The list of functions corresponds with the command types above (e.g., CD, DSS, etc.).

Source Names (Pages 104-105)

A list of assignable Source Names is provided for advance selection and source form completion before programming.

Flow Charts (Pages 64-76)

Installation Menu flow charts provide a graphical representation of the programming process.

Installation Menu (Pages 49-63)

The Installation Menu provides the step-by-step complete programming procedure for the keypad and the controller.

Although you can begin programming at any point within the Installation Menu, the following sequence is recommended for initial installations, as it progresses from the most basic requirements to the more advanced features.

1. Controller Setup (CTRLR SETUP) (Page 58-59)

This procedure sets the controller ID number within the system. This number must be manually set when multiple CAM6.6's are linked through RNET within one system. This procedure is not necessary for systems with only one CAM6.6.

2. Number of Sources (# of Sources/SOURCE SETUP) (Page 57)

This procedure sets the number of sources used in the system. This prevents the user from selecting a source input that is not used.

INSTALLER

SYSTEM PROGRAMMING OVERVIEW

3. Basic Setup (SOURCE SETUP) (Pages 51-53)

This procedure is mandatory to set up each source for keypad source control and is the cornerstone of the programming process.

4. Peripheral Setup (Pages 49-51) (FOR OPTIONAL INTERNAL SOURCE)

This procedure provides setup and naming procedures for the tuner. It includes assigning a custom name to a memory preset or bank, and choosing a region for AM/FM operation (US or Euro).

5. Learn IR (Page 61)

This procedure is used when the source-specific IR code is not found in the built-in IR code library. This allows IR commands to be learned into the system and centrally stored.

6. Macro Editor (Pages 62-63)

This procedure compiles multiple IR keycodes to be initiated by a single button press. One macro can have up to 10 commands, including other macros, and up to 132 macros can be entered.

7. Source Volume Trim (SOURCE SETUP) (Page 54)

This procedure matches audio output signals for all sources for seamless switching.

8. Numeric IR (SOURCE SETUP) (Pages 54-56)

This procedure sets up control of a source that supports direct numeric commands.

9. Key Configuration (SOURCE SETUP) (Pages 53-54)

This procedure customizes individual key functions on a per-zone basis for source control.

10. Power Management (Pages 59-61)

This function incorporates IR macro commands to automatically control the power state of the sources when the system is in use or when a home theater is sharing sources.

11. Zone Volume Trim (ZONE SETUP) (Page 58)

This procedure limits the maximum volume allowed in a zone, regardless of keypad volume adjustment.

12. System On Enable (SYSON ENABLE/ZONE SETUP) (Page 58)

This feature allows a zone to join or opt out of an "all on" command.

13. Party Enable (ZONE SETUP) (Page 58)

This feature allows a zone to join or opt out of Party Mode participation.

14. Master Enable (ZONE SETUP) (Page 58)

This feature allows a zone the option of becoming a Master keypad in Party Mode.

15. Mute Enable (ZONE SETUP) (Page 58)

This feature allows a zone to allow or mute audio.













INSTALLER

INSTALLATION MENU OVERVIEW

There are three item types in the installation menu:

- Menu** – “Folder” that holds procedures and/or feature options.
- Procedure** – A series of steps to perform a guided operation, such as configuring a button.
- Feature** – The actual settings that will change the system configuration.

The following **UNO-S1** and **UNO-S2** buttons are used to navigate and make selections while using the installation menus. The UNO-TS2 does not support access to the Installation Menu.

UNO-S1	UNO-S2	Button Function
		Setup button (located under cover plate on the keypad's right side) - Press and release while in normal operating mode to enter the Installation Menu. Press to back out of any procedure and return to beginning of Installation Menu, then to normal operating mode.
		Adjust feature setting (increment)
		Adjust feature setting (decrement)
		Go to next menu / procedure / feature. Not available while performing a procedure
		Go to previous menu / procedure / feature. Not available while performing a procedure
		Enter menu / begin procedure / show current feature setting. While performing a procedure, it is also used to advance to the next sequential feature setting once the current feature has been viewed or adjusted.

UNO-S1 Keypad Five-character Display

The UNO-S1 keypad abbreviates information as necessary to appear in its five-character display. In the following menu procedures, the UNO-S1 five-character abbreviation is shown in parentheses underneath the 12-character version.

INSTALLER INSTALLATION MENU

The following items make up the Installation Menu:

PERIPH SETUP (PerSu) (▶) SOURCE SETUP (SrcSu) (▶) ZONE SETUP (ZonSu) (▶)
CTRLR SETUP (CtlSu) (▶) POWER MGT (PwMgt) (▶) LEARN IR (LrnIR) (▶)
MACRO EDITOR (MacEd) (▶) SYSTEM INFO (SInfo) (▶)

PERIPH SETUP (PerSu)

Note: For CAM6.6, Peripheral Setup is not applicable. "Not Avail" shows on the keypad.

Peripheral Setup allows the CAM6.6's optional internal source to be configured.

The following items can be found in the PERIPH SETUP menu:

MEM NAME (MemNm) (▶) BANK NAME (BnkNm) (▶) CONTROLLER ID (CtlId) (▶) REGION (Rgion) (▶)
FACTORY INIT (FInit) (▶) SYSTEM INFO (SInfo) (▶)

MEM NAME (MemNm)

NOTE: A memory preset must be created and saved before it can be named. Once it is saved, the preset's Tuner #, Bank # and Memory # must be entered in the following procedure.

This procedure accesses a name entry field to enter a custom name for a memory preset. **See Periph Setup - Flow Chart on page 64**

- 1. BANK # –** Select the BANK # of the memory preset.
(Bank#)
- 2. MEMORY # –** Select the MEMORY # of the preset to be named.
(Mem #)
- 3. MEMORY NAME –** Use the volume up/down keys to select a character and left/right
(MemNm) keys to change a character position. A blinking cursor indicates placement of the character being entered. Names can be from 1 to 5 characters in length. If adding names from 6-12 characters, it is suggested you use an optional UNO-S2 keypad.

BANK NAME (BnkNm)

This procedure accesses a name entry field to enter a custom name for each of the tuner's six banks. **See Periph Setup - Flow Chart on page 64**

- 1. BANK # –** Select the BANK # of the memory preset.
(Bank#)

(continued)

INSTALLER

INSTALLATION MENU

2. **BANK NAME** – (BnkNm) Use the volume up/down keys to select a character and left/right keys to change a character position. A blinking cursor indicates placement of the character being entered. Names can be from 1 to 5 characters in length. If adding names from 6-12 characters, it is suggested you use an optional UNO-S2 keypad.

CONTROLLR ID (Ctld)

This procedure is used to identify the controller(s) that the tuner will respond to. **See Periph Setup - Flow Chart on page 65**

1. **Controller:#** – (Ctld) Select controller ID of controller that will control the tuner.
2. **All controllers** – (All) Select if all controllers in the system can control the tuner.

REGION (Rgion)

This procedure assigns either US or Euro frequency display to the tuner. The difference between the two is that US FM frequencies operate in .2 MHz increments, while European FM frequencies operate in .05 MHz increments. **See Periph Setup - Flow Chart on page 65**

1. **US** – (US) Select US for US FM frequency display.
2. **EURO** – (Euro) Select EURO for EURO FM frequency display.

FACTORY INIT (Flnit)

NOTE: This procedure returns the tuner to its factory settings and erases all user settings.

This procedure allows the erasure of all programmed settings and returns them to the factory default settings. **See Periph Setup - Flow Chart on page 65**

1. **Are you sure?** – (Sure?) Confirmation of YES or NO is required to proceed. A NO selection returns to the top of the Factory Initialization menu. A YES selection begins the initialization.
2. **Please Wait** – Message shows during the initialization process.
3. **Cycle Power** – When initialization is complete, cycle power to the unit.

SYSTEM INFO (SInfo)

System Info shows the tuner's manufacturing build properties. *See Periph Setup - Flow Chart on page 65*

BUILD TIME (BTime) (▶) BUILD DATE (BDate) (▶) VERSION (Ver) (▶)

1. **BUILD TIME** (BTime) Displays the firmware Build Time of the tuner.
2. **BUILD DATE** (BDate) Displays the firmware Build Date of the tuner.
3. **VERSION** (Ver) Displays the firmware version of the tuner.

SOURCE SETUP (SrcSu)

Source Setup allows the system's sources to be configured.

The following items can be found in the SOURCE SETUP menu:

BASIC SETUP (BasSu) (▶) KEY CONFIG (KeyCf) (▶) SOURCE NAMES (SrcNm) (▶)

SRC VOL TRIM (SrcVT) (▶) NUMERIC IR (NumIR) (▶) SRC SEL CMD (SrcSC) (▶)

OF SOURCES (#Srcs) (▶)

BASIC SETUP (BasSu)

NOTE: The BASIC SETUP procedure should be performed for each source before proceeding to other source setting changes.

Note: If the CAM6.6 has an optional internal source installed, it is pre-configured as Source 1, with source name Tuner and command type Peripheral.

This procedure uses built-in source "templates" to quickly and easily configure the source settings needed for basic operation of the source component. Before performing BASIC SETUP, connect the source components to the CAM6.6 as outlined in the Source Connections section. Also be sure that all sources are powered on. *See Basic Setup - Flow Chart on page 66*

1. **SOURCE NUM** – Select the source to be configured.
(Src #)

(continued)

INSTALLER

INSTALLATION MENU

- 2. SOURCE NAME –** (Name) Select the name for the source (e.g., DVD, Aux 2, Jazz, etc.).
- 3. COMMAND TYPE –** (CmdTp) Select the type of command template (e.g., CD, TV, etc.). Selecting the command type template will tell the CAM 6.6 how to configure the key's command and text for the source component.
- a. Selected: Learned IR** (LrnIR) Choose Learned IR if the pre-programmed IR code library does not support the source component.
- i. LEARNED SRC –** (LnSrc) Select the learned source bank to be assigned to the source component. (See Learning IR procedure for instructions on how to learn IR codes.)
- ii. TEMPLATE TYP –** (TType) Select the template type to define what type of source component is being used. (This will tell the CAM6.6 how to configure the key commands and text for the source component if it is a learned source.) Procedure advances to USE NUM IR? (step 7).
- b. Selected: Unassigned** (Unasg) The template for the selected source is cleared. (All key assignments and other source settings will be erased.) Procedure advances to SAVE CHANGES (step 10)
- c. All Other Selections:** Procedure advances to DEVICE CODE (step 4)
- 4. DEVICE CODE –** (DevCd) Enter source component code number listed in this manual's Reference section.
- 5. TEST IR? –** (TstIR) If "Yes" is selected, the CAM6.6 sends a power command to the source component. If "No" is selected, the procedure advances to USE NUM IR? (step 7)
- 6. SUCCESS? –** (OK?) If the power to the source component was turned off, select "Yes" otherwise select "No." By selecting "No" the Procedure returns to DEVICE CODE (step 4) to allow selection of another code number from the provided list.
- 7. USE NUM IR? –** (NumIR) Indicates the source component has numeric scrolling, such as multi-disc CD player (See NUMERIC IR Setup Procedure for advanced settings or more information). "No" advances menu to AUTO PLAY (step 9).
- 8. HIGHEST NUM –** (High#) Enter the highest possible number; for example, a 100-disc CD player would have a max number of 100.

- 9. AUTO PLAY?** – (AtoPl) “Yes” tells the CAM6.6 to issue a PLAY command whenever the source is selected for listening. This option is skipped if the source type (COMMAND TYPE) chosen does not have a PLAY command associated with it.
- 10. SAVE CHANGES?** – (Save?) Select “yes” to save changes. Procedure returns to SOURCE NUM to allow configuration of another source.

KEY CONFIG (KeyCf)

Key Configuration defines zone-specific key functions for each source. **See Key Config. - Flow Chart on page 67**

- 1. ZONE NUM** – (Zone#) Select the zone the key will be configured for. Changes are made for that zone only; default setting is “All Zones.”
- 2. SOURCE NUM** – (Src #) Select the source the key will be configured for.
- 3. SELECT A KEY** – (SelKy) Using + or -, select the keypad key to be configured.
- 4. KEY TYPE** – (KeyTp) Either “Key Press,” “Key Hold” or “Both” will activate the command.
- 5. KEY NAME** – (KeyNm) Name that appears on the keypad display when the command is activated.
- 6. COMMAND TYPE** – (CmdTp) Select the type of source command (e.g., CD, DVD, etc.).
- a. Selected: Learned IR** – (LrnIR) Choose Learned IR if the pre-programmed IR code library does not support the source component.
 - i. LEARNED SRC** – (LnSrc) Select the learned source bank to be assigned to the source component. Procedure advances to KEY FUNCTION (step 8)
 - b. Selected: Unassigned** (Unasg) The key configuration is cleared. Procedure advances to SAVE CHANGES (step 9)
 - c. Selected: Default** (Deflt) Default selects the same device type and device code previously setup in BASIC SETUP. Procedure advances to KEY FUNCTION (step 8)
 - d. Selected: Macro:** (Macro) **(To build macros, see Macro Editor page 62)**

(continued)

INSTALLER INSTALLATION MENU

- i. **MACRO** - (Macro) Macro loads a series of commands which are processed when activated.
 - ii. **MACRO ID** - (MacID) Enter the macro ID number. Menu advances to SAVE CHANGES (step 9)
 - e. **All Other Selections:** Procedure advances to DEVICE CODE (step 7)
- 7. **DEVICE CODE** - (DevCd) Enter source component code number listed in this manual's Reference section.
 - 8. **KEY FUNCTION** - (KeyFn) Select a function for the button.
 - 9. **SAVE CHANGES?** - (Save?) Select "yes" to save changes. Procedure advances to ZONE NUM (step 1)

SOURCE NAMES (SrcNm)

This procedure allows the installer to customize the source names for the sources attached to the CAM6.6. **See Source Names/Vol Trim - Flow Chart on page 68**

- 1. **SOURCE NUM** - (Src #) Select the source number this name will be assigned to.
- 2. **SOURCE NAME** - (Name) Select the name. SOURCE NUM will reappear on the LCD panel; repeat the instructions for each source to be labeled.

SRC VOL TRIM (SrcVT)

This procedure allows the installer to adjust the output level of an individual source. The output volume is adjustable by 16dB. At 0dB (-3dB is the default setting), the volume is at max output; at -16dB the volume is at the lowest setting possible for that source only. **See Source Names/Vol Trim - Flow Chart on page 68**

- 1. **SOURCE NUM** - (Src #) Select the source number this level will be set for.
- 2. **TRIM LEVEL** - (Trim) 0dB is max output volume, -16dB is lowest setting.

NUMERIC IR (NumIR)

Numeric IR allows the installer to program source specific number functions (Channel 12, Disk 89, etc.).
See Numeric IR - Flow Chart on page 69 (continued)

INSTALLER INSTALLATION MENU

1. **SOURCE NUM** – (Src #) Select the source number this function will be configured for.
2. **USE NUM IR?** – (NumIR) Tells the system whether the source component has numeric scrolling, such as 100-disc CD player. A selection of “no” disables Numeric IR and advances to SAVE CHANGES
3. **HIGHEST NUM** – (High#) Enter the highest possible number; for example, the 100-disc CD player would have a max number of 100.
4. **NUMERIC TEXT** – (NmTxt) Select Numeric descriptive text.
5. **PREFIX CMD** – (Prefx) Tells the system whether a command will be issued prior to the selection of the numerical value (e.g., Disc 1,2). If “no,” procedure advances to SUFFIX CMD (step 9)
6. **COMMAND TYPE** – (CmdTp) Select the type of command (e.g., CD, TV, etc.).
 - a. **Selected: Learned IR** (LrnIR) Choose Learned IR if the pre-programmed IR code library does not support the source component.
 - i. **LEARNED SRC** – (LnSrc) Select the learned source bank to be assigned to the source component. Procedure advances to KEY FUNCTION (step 8)
 - b. **Selected: Unassigned** (Unasg) The numeric IR Prefix command is cleared. Procedure advances to SUFFIX CMD (step 9)
 - c. **Selected: Default** (Deflt) Default selects the same device type and device code previously setup in BASIC SETUP. Procedure advances to KEY FUNCTION (step 8)
 - d. **Selected: Macro:** (Macro) **(To build macros, see Macro Editor page 62)**
 - i. **MACRO** - (Macro) Macro loads a series of commands which are processed when activated.
 - ii. **MACRO ID** – (MacID) Enter the macro ID number. Menu advances to SUFFIX CMD (step 9)
 - e. **All Other Selections:** Procedure advances to DEVICE CODE (step 7)
7. **DEVICE CODE** – (DevCd) Source component code for IR control.
8. **KEY FUNCTION** – (KeyFn) Select a function (Disc, etc.).

(continued)

INSTALLER INSTALLATION MENU

- 9. SUFFIX CMD –**
(Suffix) Tells the system whether a command will be issued after the selection of the numerical value (e.g., 1, 2 *Enter*). If “no,” procedure advances to SAVE CHANGES (step 13)
- 10. COMMAND TYPE –**
(CmdTp) Select the type of source command (e.g., CD, TV, etc.).
- a. Selected: Learned IR**
(LrnIR) Choose Learned IR if the pre-programmed IR code library does not support the source component.
- i. LEARNED SRC –**
(LnSrc) Select the learned source bank to be assigned to the source component. Procedure advances to KEY FUNCTION (step 12)
- b. Selected: Unassigned**
(Unasg) The numeric IR Suffix command is cleared. Procedure advances to SOURCE NUM (step 1)
- c. Selected: Default**
(Deflt) Default selects the same device type and device code previously setup in BASIC SETUP. Procedure advances to KEY FUNCTION (step 12)
- d. Selected: Macro:**
(Macro) **(To build macros, see Macro Editor page 62)**
- i. MACRO -**
(Macro) Macro loads a series of commands which are processed when activated.
- ii. MACRO ID –**
(MacID) Enter the macro ID number. Menu advances to SAVE CHANGES (step 13)
- e. All Other Selections:** Procedure advances to DEVICE CODE (step 11)
- 11. DEVICE CODE –**
(DevCd) Source component code for IR control.
- 12. KEY FUNCTION –**
(KeyFn) Select a function (Enter, Play, etc.).
- 13. SAVE CHANGES? –**
(Save?) Select “yes” to save the changes.

SRC SEL CMD (SrcSC)

This procedure permits a command to be sent to the source component when the source component is initially selected. **See Source Select Command & # Of Sources - Flow Chart on page 70**

- 1. SOURCE NUM –**
(Src #) Select the source number this command will be configured for.

(Continued next page)

INSTALLER INSTALLATION MENU

- 2. COMMAND TYPE –** (CmdTp) Select the type of source command (e.g., CD, TV, etc.).
- a. Selected: Learned IR** (LrnIR) Choose Learned IR if the pre-programmed IR code library does not support the source component.
 - i. LEARNED SRC –** (LnSrc) Select the learned source bank to be assigned to the source component. Procedure advances to KEY FUNCTION (step 4)
 - b. Selected: Unassigned** (Unasg) The source select command is cleared. Procedure advances to SAVE CHANGES (step 5)
 - c. Selected: Default** (Deflt) Default selects the same device type and device code previously setup in BASIC SETUP. Procedure advances to KEY FUNCTION (step 4)
 - d. Selected: Macro:** (Macro) **(To build macros, see Macro Editor page 62)**
 - i. MACRO -** (Macro) Macro loads a series of commands which are processed when activated.
 - ii. MACRO ID –** (MacID) Enter the macro ID number. Menu advances to SAVE CHANGES (step 5)
 - e. All Other Selections:** Procedure advances to DEVICE CODE (step 3)
- 3. DEVICE CODE –** (DevCd) Source component code for IR control.
- 4. KEY FUNCTION –** (KeyFn) Select a function (Play, Enter, etc.).
- 5. SAVE CHANGES? –** (Save?) Select “yes” to save the changes.

OF SOURCES (#Srcs)





At this field it is necessary to enter the number of sources used in the CAM6.6 system (1 to 6). This limits the sources displayed on the keypad in the normal running mode when the source button is pressed, but also limits source selections in the configuration menus. **See Source Select Command & # Of Sources - Flow Chart on page 70**

INSTALLER INSTALLATION MENU

ZONE SETUP (ZonSu)

NOTE: This procedure should be performed using the keypad installed in the zone to be configured. See *Zone Setup - Flow Chart on page 71*

Zone Setup allows the installer to adjust properties of the UNO Keypad controlled CAM6.6 zone. This series of menus allows the system's zones to be configured for these properties:

ZON VOL TRIM (ZonVT)  SYSON ENABLE (SysOn)  PARTY ENABLE (PtyEn) 
MASTER ENABL (MstEn)  MUTE ENABLE (MutEn) 

- 1. ZON VOL TRIM**
(ZonVT) This feature allows the installer to adjust the output volume to each zone. -16dB (lowest) to 0dB (max)(-3DB default).
- 2. SYSON ENABLE**
(SysOn) This feature is either disabled or enabled. If disabled (default), an All On command activated from another zone will not turn on the disabled zone. If enabled, an All On command activated from another zone will turn on the enabled zone.
- 3. PARTY ENABLE**
(PtyEn) This feature is either disabled or enabled. If disabled, Party Mode activation from another zone will not affect the disabled zone. If enabled (default), the zone will participate with Party Mode.
- 4. MASTER ENABLE**
(MstEn) This feature is either disabled or enabled. If disabled, the zone cannot host a master keypad during Party Mode. If enabled (default), the zone has the option of hosting the Master keypad.
- 5. MUTE ENABLE**
(MutEn) This feature is either disabled or enabled. It allows the option of enabling or disabling muting in a zone. If disabled, the zone will not mute. If enabled (default), the zone will be muted when a mute signal is received.

CTRLR SETUP (CtIld)

Controller Setup is the basic configuration of the controller. This setup menu selects the options for Controller ID and Factory Initialization. See *Controller Setup - Flow Chart on page 72*

- 1. CONTROLLER ID**
(CtIld) This defines the Controller ID for this system. The default is 1 but when multiple controllers are used, each additional controller ID must be sequential and unique and be set before being connected to the system. Note that the system must be restarted before the controller will assume the new ID.

(continued next page)

2. FACTORY INIT (Flnit)

WARNING: This procedure returns the controller to its original settings - use with discretion.

Factory Initialization allows the installer to erase all programmed settings and returns the settings to the factory default settings. All settings including source equipment IR commands will need to be reentered. An "Are you sure?" prompt and a "no" response allows the installer to cancel the reset; a "yes" at the prompt will load factory/default settings.

POWER MANAGEMENT (PwMgt)

The CAM6.6 is capable of managing the power state of the connected source equipment. The power management is configured on a source-by-source basis.

All sources that have power management enabled are initialized by a "POWER ON" command or macro. Power management is initialized when the first keypad is turned on or when the home theater trigger input has 12VDC present. The 12VDC trigger output is turned on when the first zone is turned on.

All sources that have power management enabled are turned off by the "POWER OFF" command after all zones have been turned off, with a timeout of five minutes. The 12VDC trigger output is turned off one minute after that. This timeout is postponed for as long as the home theater trigger input has 12VDC present. **See Power Management - Flow Chart on page 73**

- | | |
|-------------------------------------------|-----------------------------------------------------------------------------------------------------------------------------------------------------------------------------------------|
| 1. SOURCE NUM –
(Src #) | Select the source number this feature will be configured for. |
| 2. POWER ON CMD –
(OnCmd) | Tells the controller to turn on the selected source equipment (by SOURCE NUMBER) when any of the UNO System Keypads is turned on. If "no," procedure advances to POWER OFF CMD (step 6) |
| 3. COMMAND TYPE –
(CmdTp) | Select the type of source command (e.g., CD, TV, etc.). |
| a. Selected: Learned IR
(LrnIR) | Choose Learned IR if the pre-programmed IR code library does not support the source component. |
| i. LEARNED SRC –
(LnSrc) | Select the learned source bank to be assigned to the source component. Procedure advances to KEY FUNCTION (step 5) |
| b. Selected: Unassigned
(Unasg) | The Power On command is cleared. Procedure advances to POWER OFF CMD (step 6) |

(continued)

INSTALLER

INSTALLATION MENU

- c. **Selected: Default**
(Deflt) Default selects the same device type and device code previously setup in BASIC SETUP. Procedure advances to KEY FUNCTION (step 5)
 - d. **Selected: Macro:**
(Macro) **(To build macros, see Macro Editor page 62)**
 - i. **MACRO -**
(Macro) Macro loads a series of commands which are processed when activated.
 - ii. **MACRO ID -**
(MacID) Enter the macro ID number. Menu advances to POWER OFF CMD (step 6)
 - e. **All Other Selections:** Procedure advances to DEVICE CODE (step 4)
- 4. **DEVICE CODE -**
(DevCd) Source component code for IR control.
- 5. **KEY FUNCTION -**
(KeyFn) Select a function (Play, Enter, etc.).
- 6. **POWER OFF CMD -**
(OfCmd) Tells the controller to turn off the selected source equipment (by SOURCE NUMBER) when the last of the UNO System Keypads is turned off. If "no," procedure advances to SAVE CHANGES (step 10)
- 7. **COMMAND TYPE -**
(CmdTp) Select the type of source command (e.g., CD, TV, etc.).
 - a. **Selected: Learned IR**
(LrnIR) Choose Learned IR if the pre-programmed IR code library does not support the source component.
 - i. **LEARNED SRC -**
(LnSrc) Select the learned source bank to be assigned to the source component. Procedure advances to KEY FUNCTION (step 9)
 - b. **Selected: Unassigned**
(Unasg) The Power Off command is cleared. Procedure advances to SAVE CHANGES (step 10)
 - c. **Selected: Default**
(Deflt) Default selects the same device type and device code previously setup in BASIC SETUP. Procedure advances to KEY FUNCTION (step 9)
 - d. **Selected: Macro:**
(Macro) **(To build macros, see Macro Editor page 62)**
 - i. **MACRO -**
(Macro) Macro loads a series of commands which are processed when activated.
 - ii. **MACRO ID -**
(MacID) Enter the macro ID number. Menu advances to SAVE CHANGES (step 10)

(continued next page)

- e. **All Other Selections:** Procedure advances to DEVICE CODE (step 8)
- 8. **DEVICE CODE –** (DevCd) Source component code for IR control.
- 9. **KEY FUNCTION (f) –** (KeyFn) Select Keypad function.
- 10. **SAVE CHANGES? (f) –** (Save?) Select “yes” to save the changes.

LEARN IR (LrnIR)

This procedure allows IR commands to be learned into the system and be centrally stored in the main controller to let the system access the same IR codes that operate the source equipment.

NOTE: IR codes must be learned in by pointing the remote at the CAM6.6's REAR panel IR receiver only. **See Learn IR - Flow Chart on page 74**

- 1. **LEARNED SRC –** (LnSrc) Select the source (Source 1-6 and Miscellaneous Learned IR (Misc)) whose commands will be learned into the controller.
- 2. **KEY FUNCTION –** (KeyFn) Select the function to be learned or deleted.
- 3. **LEARN/DELETE –** (Ln/Dl) Select Learn IR Now or Delete IR. If Learn IR Now, a “USE REMOTE” prompt appears. Point the learning remote at the controller’s IR window. If Delete IR, procedure returns to LEARNED SRC (step 1)
- 4. **TEST IR? –** (TstIR) If “yes,” sends the learned command to the source component to test the IR. If the component responds, the IR test was a success. If the component does not respond the Code was not learned properly. If “no,” menu goes back to LEARNED SRC (step 1)
- 5. **SUCCESS? -** (OK?) Asks if the IR test was a success
 - IF YES - If the test was a success, specify “yes” and proceed to KEY FUNCTION (step 2)
 - IF NO - If the test was a failure, specify “no” and LEARN/DELETE (step 3) reappears on the display allowing another code to be learned in.

INSTALLER INSTALLATION MENU

MACRO EDITOR (*MacEd*)

This procedure is used to create a sequence of commands that are launched with one key touch or other event. Up to 132 macros can be created for the system, and each macro can contain up to 10 commands including other macros and delays. **See *Macro Editor - Flow Chart on page 75***





1. **MACRO ID** – (MacID) Number of Macro up to 132 including any previously named macros.
2. **MACRO NAME** – (MacNm) Name of Macro (optional).
3. **COMMAND NUM** – (Cmd#) Number of Command up to 10.
4. **COMMAND TYPE** – (CmdTp) Select the type of source command (e.g., CD, TV, etc.).
 - a. **Selected: Learned IR** (LrnIR) Choose Learned IR if the pre-programmed IR code library does not support the source component.
 - i. **LEARNED SRC** – (LnSrc) Select the learned source bank to be assigned to the source component. Procedure advances to KEY FUNCTION (step 6)
 - b. **Selected: Unassigned** (Unasg) Selected command and subsequent commands are cleared. Procedure advances to COMMAND NUM (step 3)
 - c. **Selected: Default** (Deflt) Default selects the same device type and device code previously setup in BASIC SETUP. Procedure advances to KEY FUNCTION (step 6)
 - d. **Selected: Macro:** (Macro)
 - i. **MACRO** - (Macro) A macro can "call" another macro if a sequence of more than 10 commands is needed.
 - ii. **MACRO ID** – (MacID) Enter the macro ID number. Menu advances to COMMAND NUM (step 3)
 - e. **Selected: Delay** (Delay) Enter a 1- to 60-second delay time to postpone delivery of the next command in the macro. Procedure advances to COMMAND NUM (step 3)
 - f. **All Other Selections:** Procedure advances to DEVICE CODE (step 5)

(continued next page)

- 5. **DEVICE CODE** - Source component code for IR control.
(DevCd)
- 6. **KEY FUNCTION** - Select a function (Play, etc.).
(KeyFn)

SYSTEM INFO (SInfo)

System Info allows the installer to view the controller's manufacturing build properties.
See System Info - Flow Chart on page 76

#CONTROLLERS (#Ctls)  BUILD TIME (BTime)  BUILD DATE (BDate)  VERSION (Ver) 

- 1. **#CONTROLLERS** Displays the number of CAM6.6 controllers in the system.
(#Ctls)
- 2. **BUILD TIME** Displays the Software Build Time of the controller.
(BTime)
- 3. **BUILD DATE** Displays the Software Build Date of the controller.
(BDate)
- 4. **VERSION** Displays the software version of the CAM6.6.
(Ver)

INSTALLER SETUP MENU FLOW CHARTS

Installation Menu

Peripheral Setup: Memory Name, Bank Name

CAUTION: Changes within the Installation Menu can affect proper operation and should be performed by qualified personnel

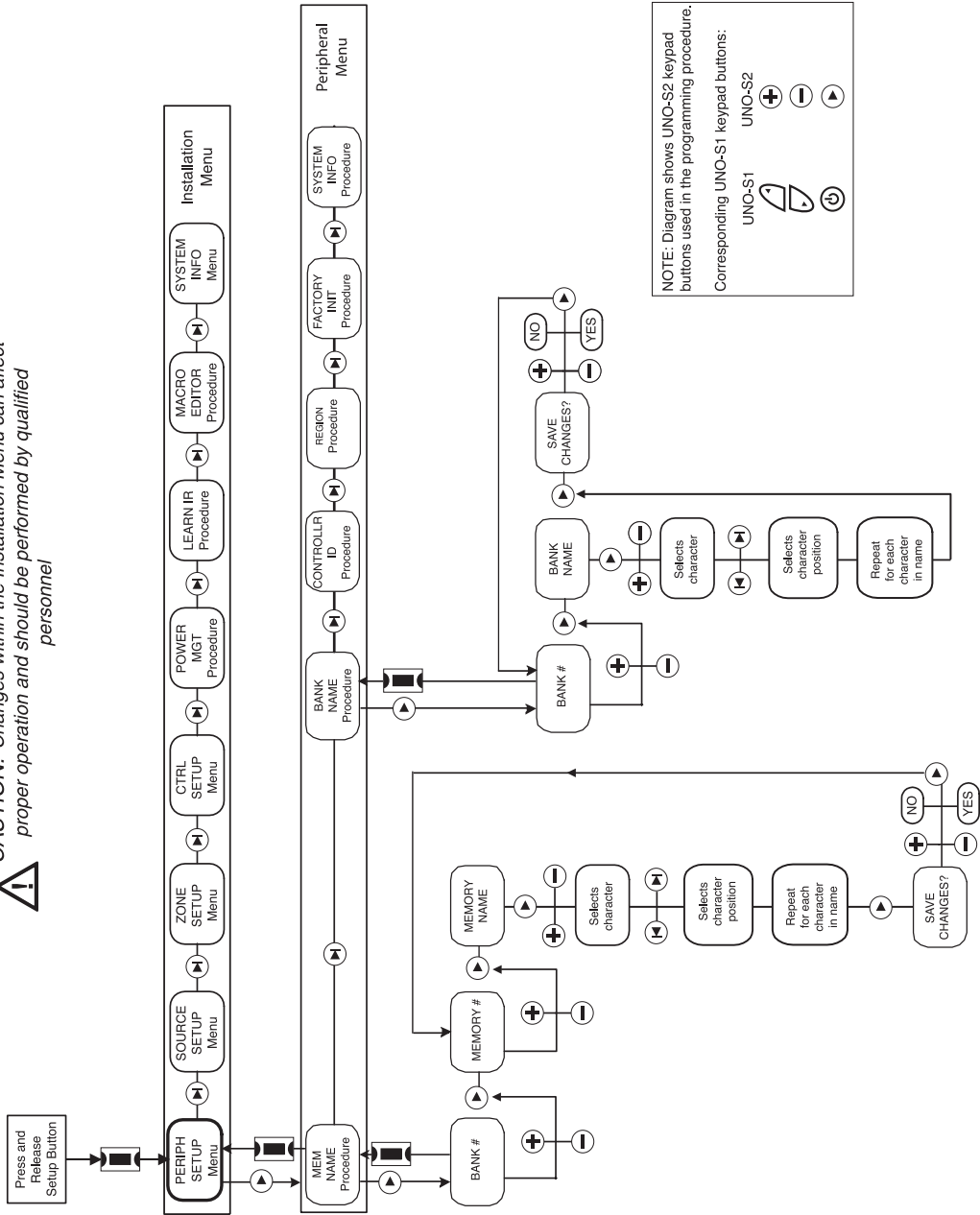

Installation Menu

Peripheral Setup: Controller ID, Region, Factory Init, System Info

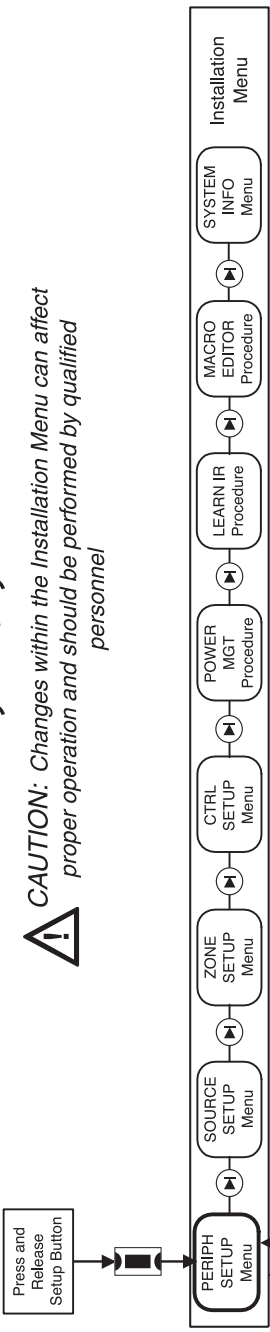

⚠ CAUTION: Changes within the Installation Menu can affect proper operation and should be performed by qualified personnel!

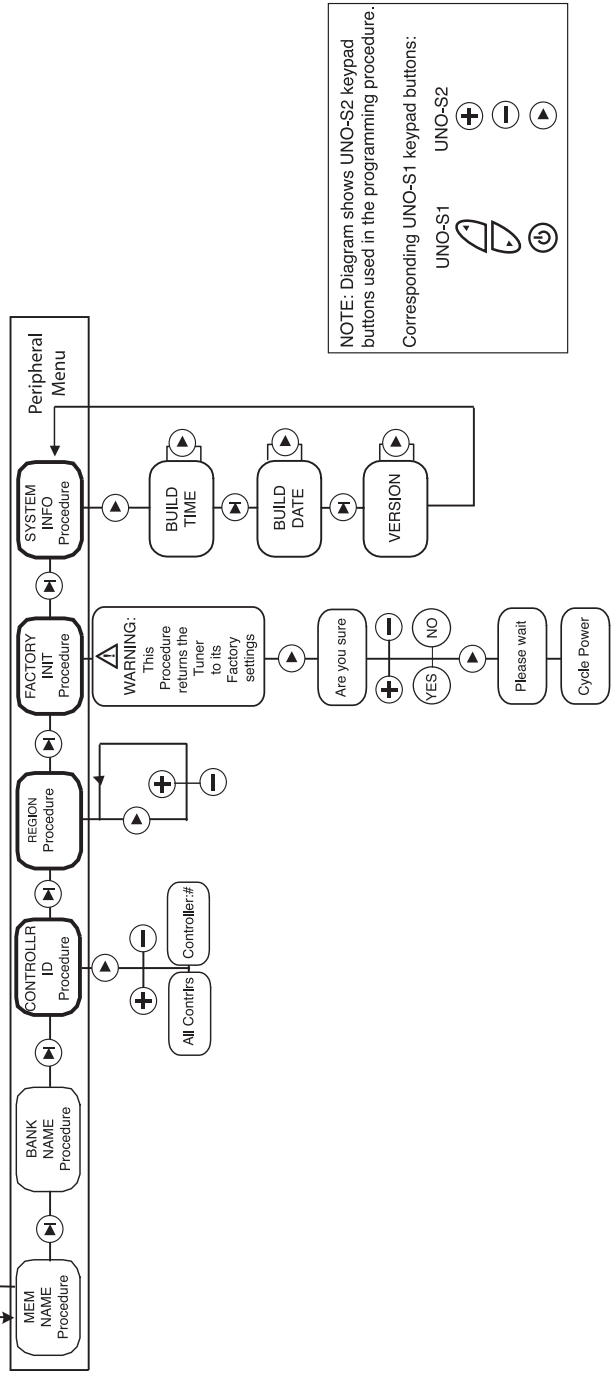

NOTE: Diagram shows UNO-S2 keypad buttons used in the programming procedure.
 Corresponding UNO-S1 keypad buttons:

UNO-S1:

UNO-S2:

INSTALLER SETUP MENU FLOW CHARTS



INSTALLER SETUP MENU FLOW CHARTS

Installation Menu

Source Setup: Basic Setup

⚠ CAUTION: Changes within the Installation Menu can affect proper operation and should be performed by qualified personnel

NOTE: Diagram shows UNO-S2 keypad buttons used in the programming procedure.
Corresponding UNO-S1 keypad buttons:

UNO-S1:  UNO-S2: 

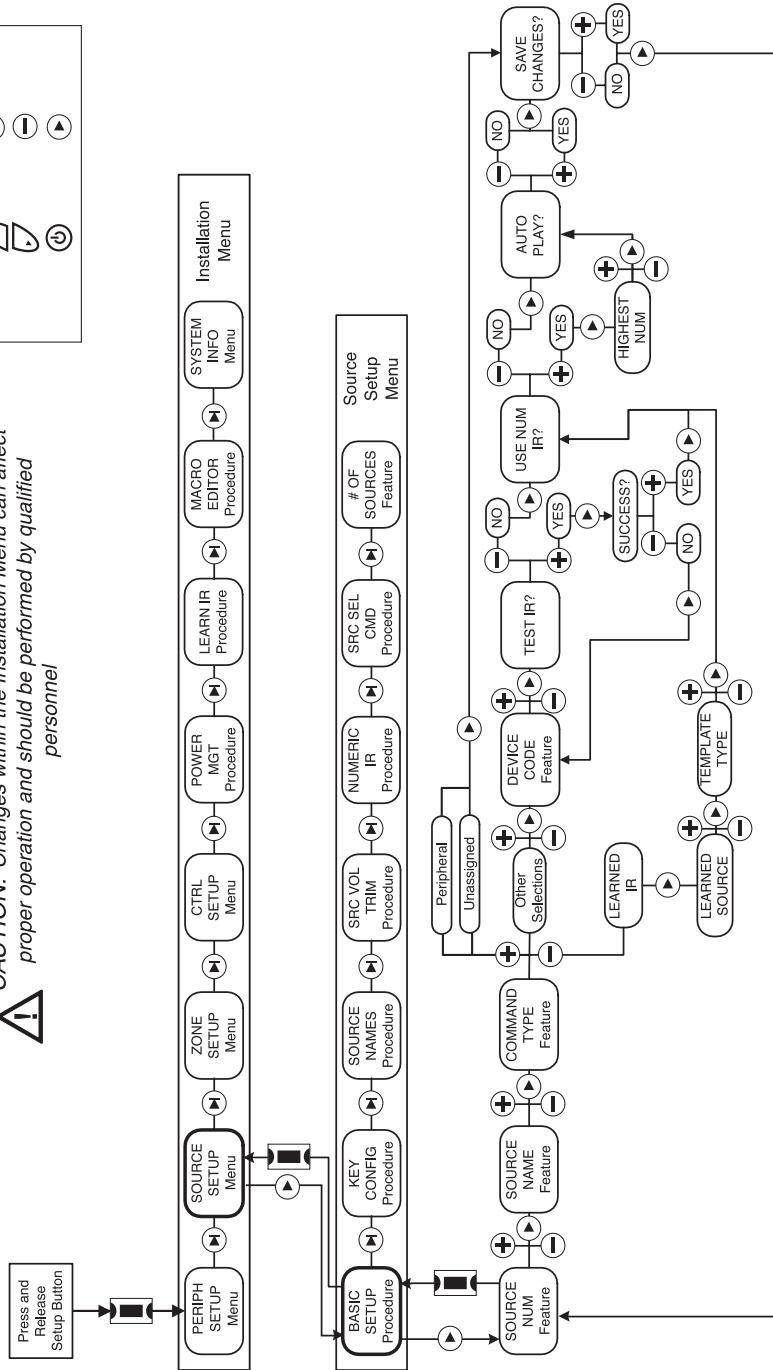



INSTALLER SETUP MENU FLOW CHARTS

Installation Menu

Source Setup: Key Configuration

CAUTION: Changes within the Installation Menu can affect proper operation and should be performed by qualified personnel

NOTE: Diagram shows UNO-S2 keypad buttons used in the programming procedure.
Corresponding UNO-S1 keypad buttons:

UNO-S1:  UNO-S2: 

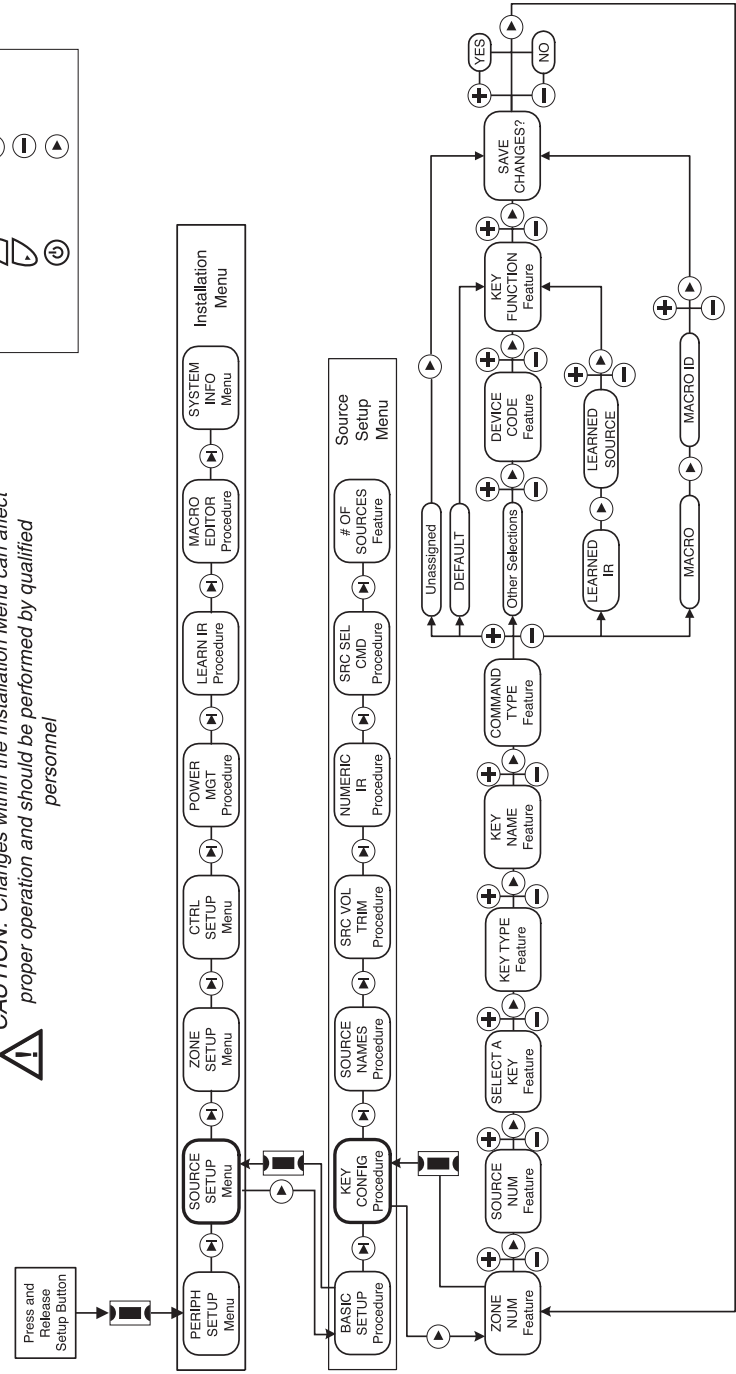

INSTALLER SETUP MENU FLOW CHARTS

Installation Menu

Source Setup: Source Names/Vol Trim

⚠ CAUTION: Changes within the Installation Menu can affect proper operation and should be performed by qualified personnel

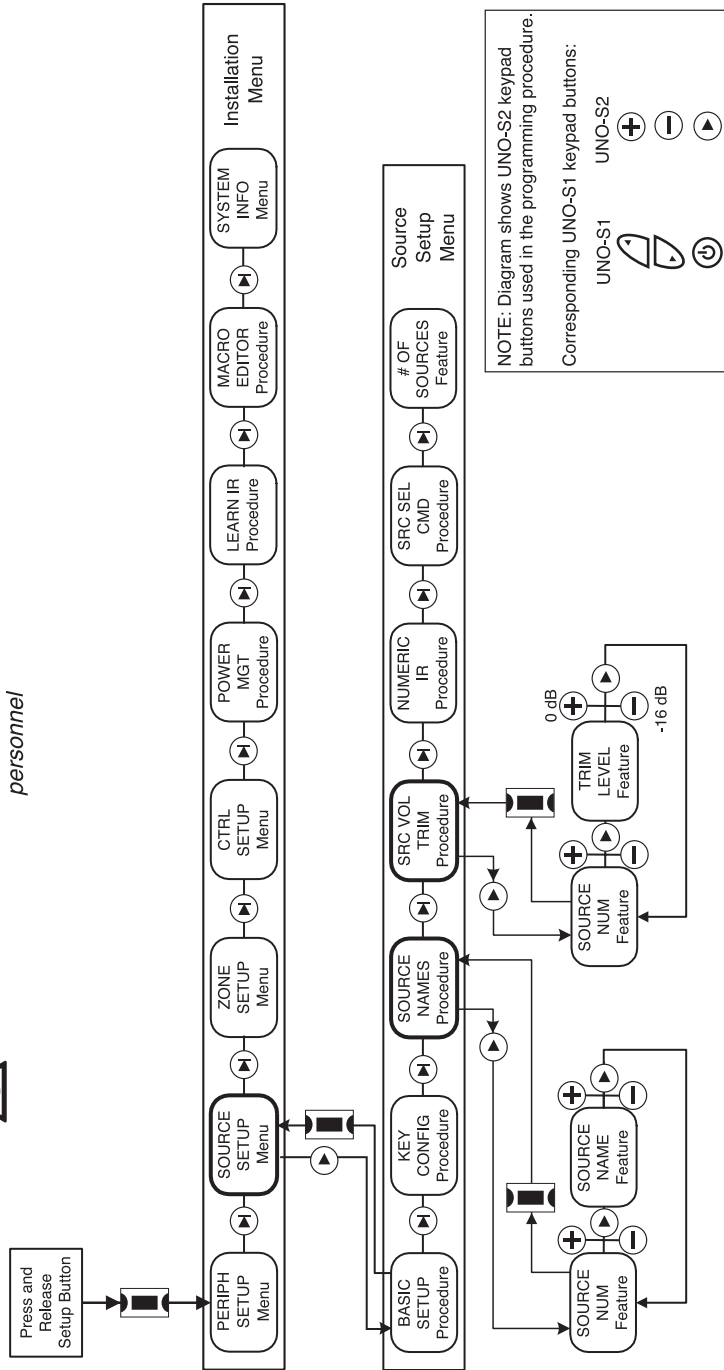

INSTALLER SETUP MENU FLOW CHARTS

Installation Menu

Source Setup: Numeric IR

CAUTION: Changes within the Installation Menu can affect proper operation and should be performed by qualified personnel

NOTE: Diagram shows UNO-S2 keypad buttons used in the programming procedure.
Corresponding UNO-S1 keypad buttons:

UNO-S1: 

UNO-S2: 

Press and Release Setup Button

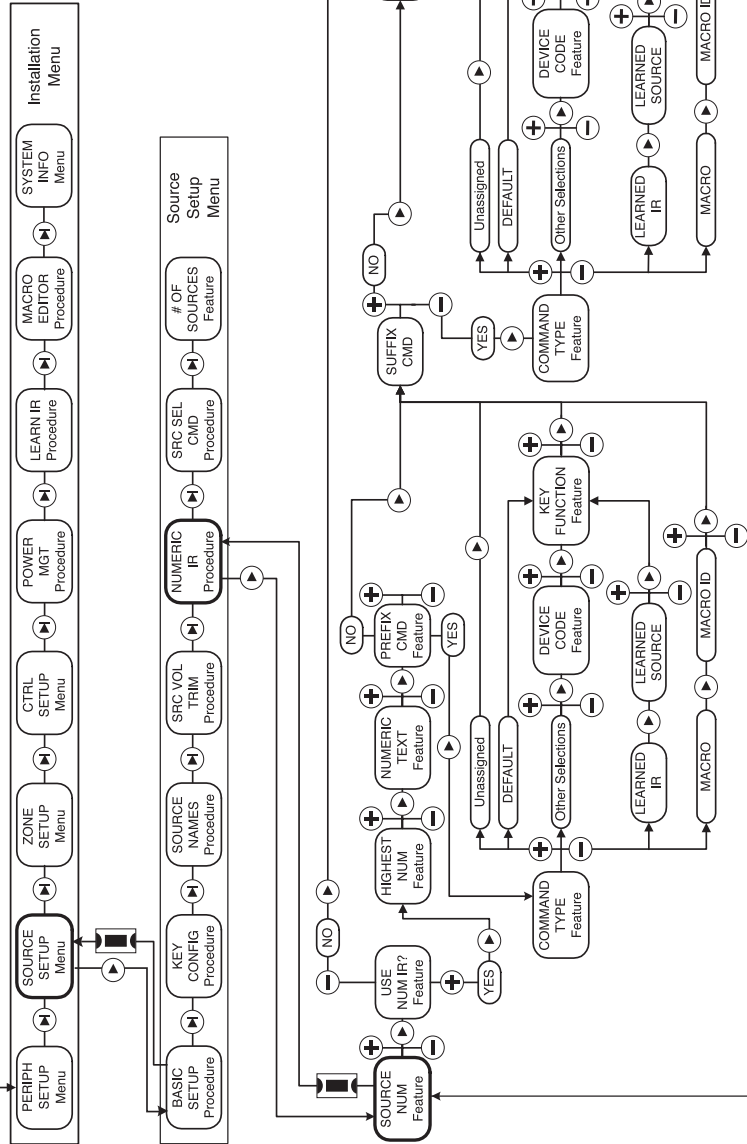

INSTALLER



SETUP MENU FLOW CHARTS

Installation Menu

Source Setup: Source Select Command # of Sources

⚠ CAUTION: Changes within the Installation Menu can affect proper operation and should be performed by qualified personnel

NOTE: Diagram shows UNO-S2 keypad buttons used in the programming procedure.
Corresponding UNO-S1 keypad buttons:

UNO-S1:  UNO-S2: 

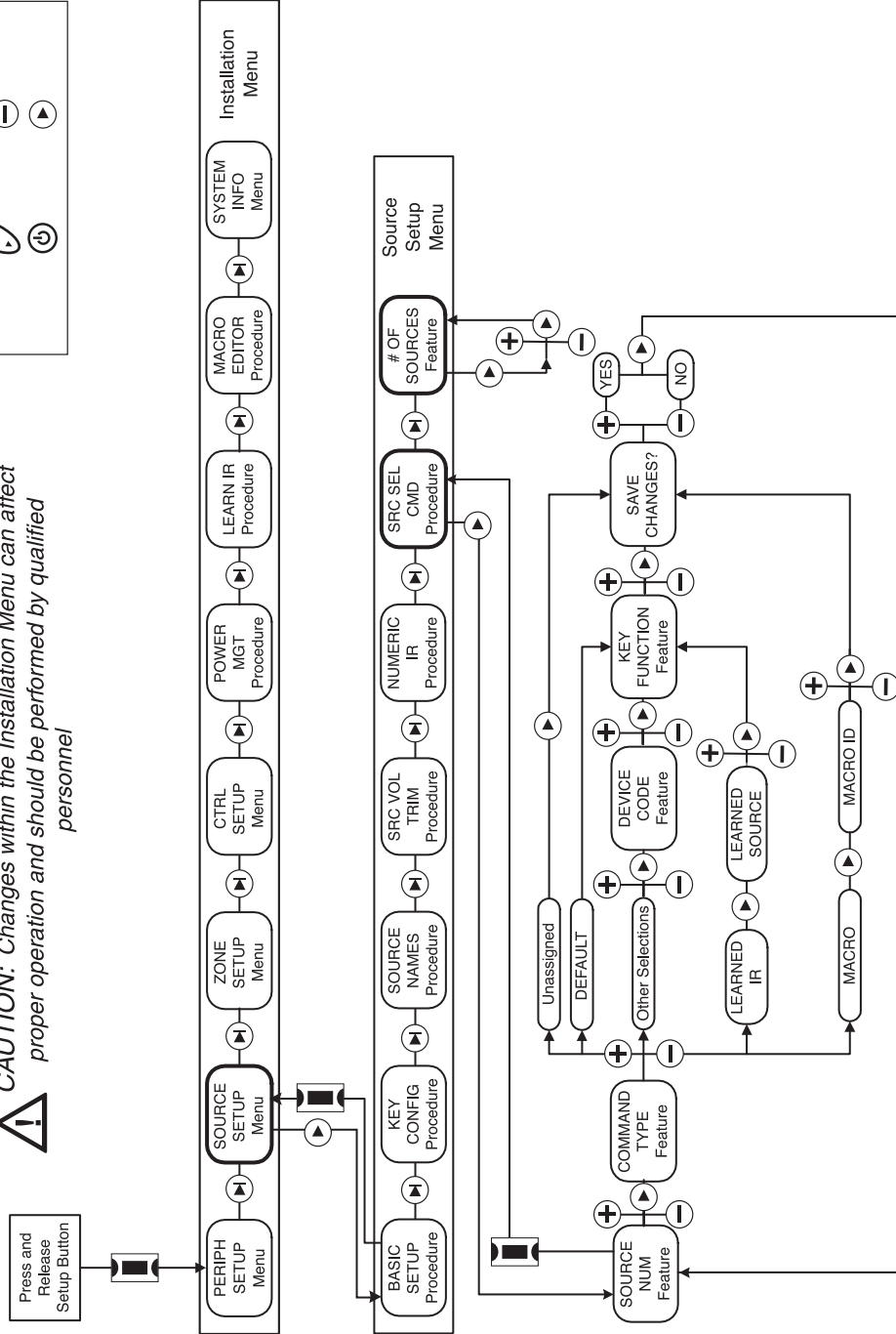

Installation Menu

Zone Setup

CAUTION: Changes within the Installation Menu can affect proper operation and should be performed by qualified personnel

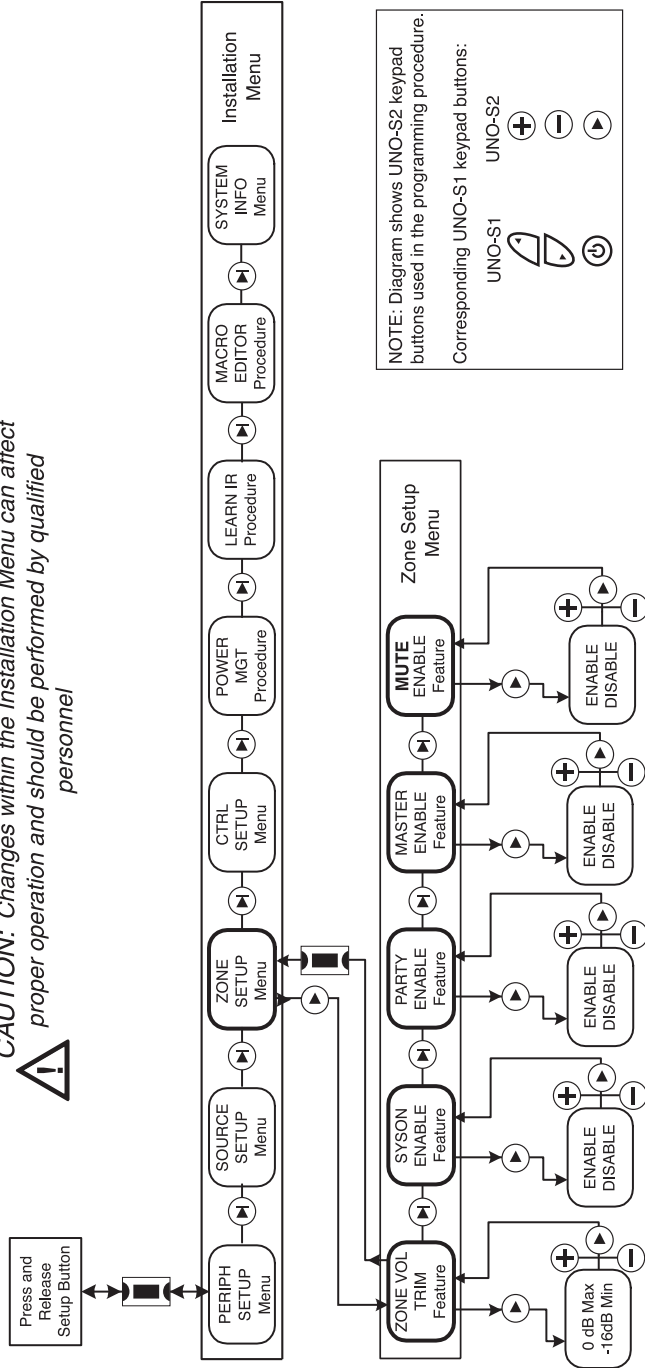

INSTALLER SETUP MENU FLOW CHARTS

Installation Menu Controller Setup

CAUTION: Changes within the Installation Menu can affect proper operation and should be performed by qualified personnel

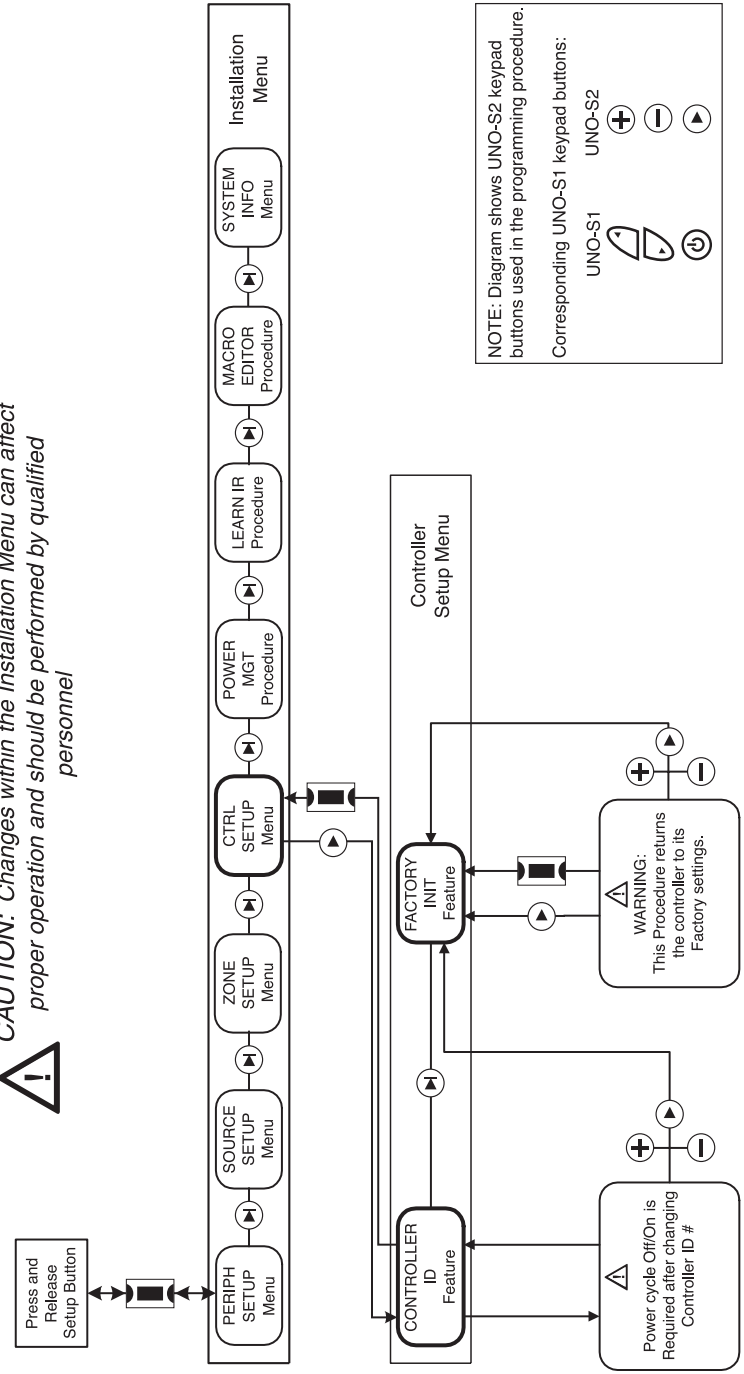



Installation Menu

Power Management

! ⚠ CAUTION: Changes within the Installation Menu can affect proper operation and should be performed by qualified personnel

NOTE: Diagram shows UNO-S2 keypad buttons used in the programming procedure.
Corresponding UNO-S1 keypad buttons:

UNO-S1: 

UNO-S2: 

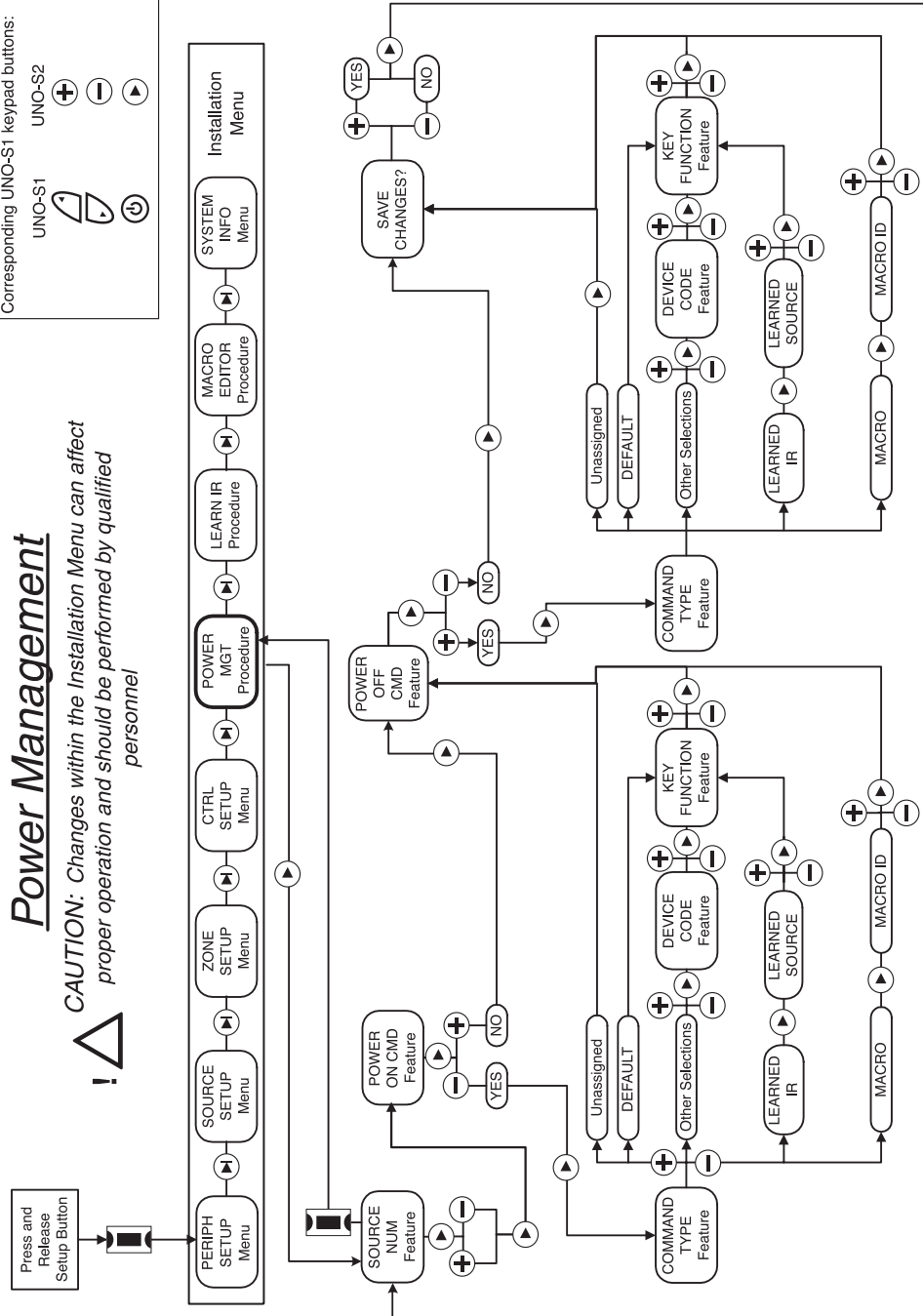

INSTALLER SETUP MENU FLOW CHARTS

Installation Menu Learn IR

⚠ CAUTION: Changes within the Installation Menu can affect proper operation and should be performed by qualified personnel

NOTE: Diagram shows UNO-S2 keypad buttons used in the programming procedure.
Corresponding UNO-S1 keypad buttons:

UNO-S1 UNO-S2

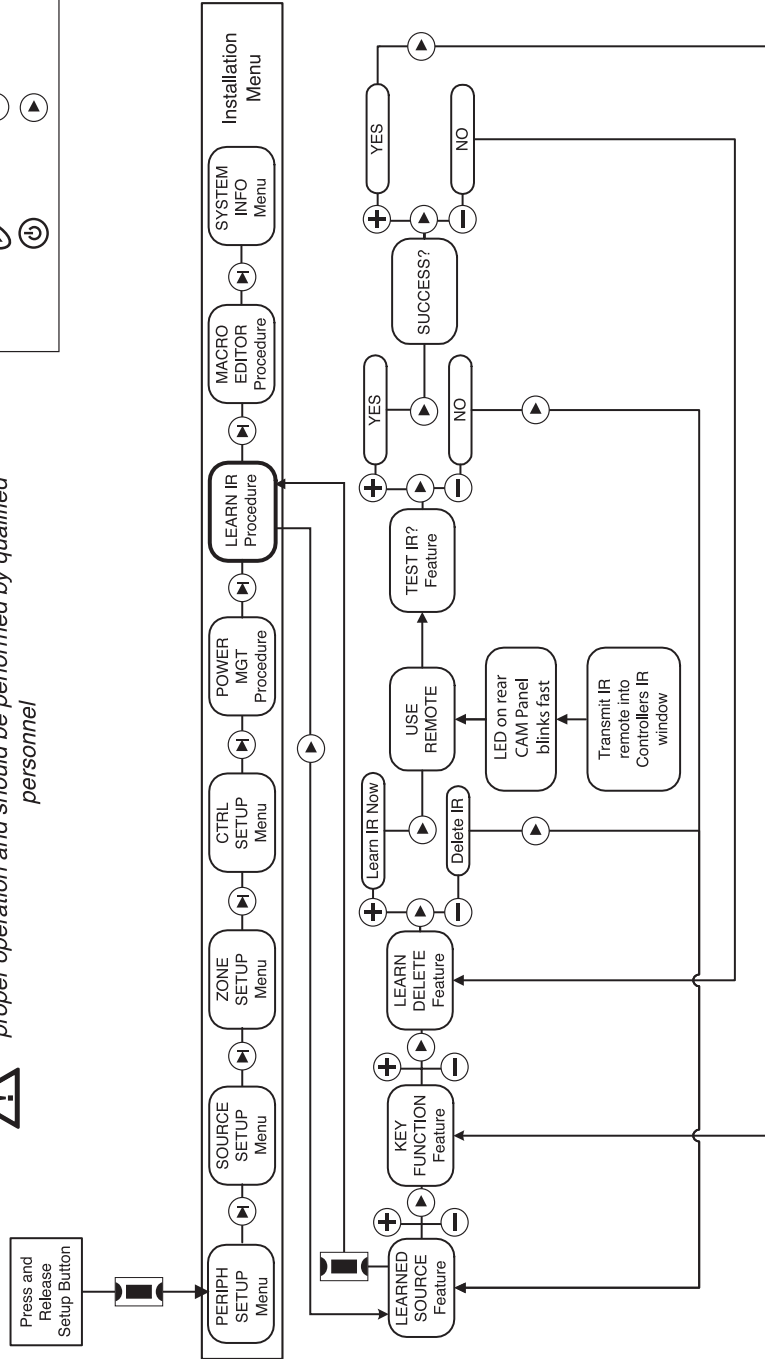

⏻ ⏪ ⏩ ⏹



Installation Menu Macro Editor

CAUTION: Changes within the Installation Menu can affect proper operation and should be performed by qualified personnel

NOTE: Diagram shows UNO-S2 keypad buttons used in the programming procedure.
Corresponding UNO-S1 keypad buttons:

UNO-S1:  UNO-S2: 

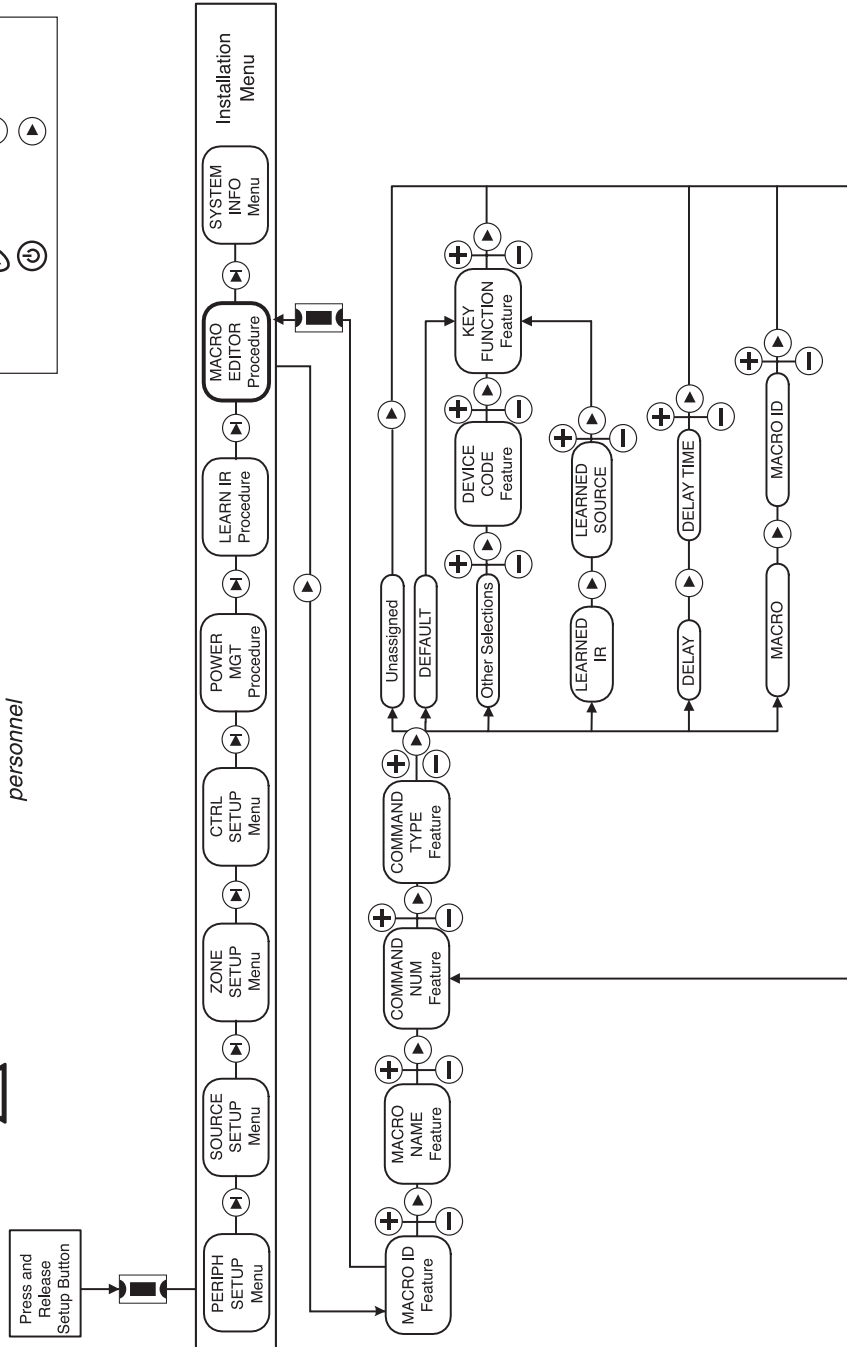



INSTALLER SETUP MENU FLOW CHARTS

Installation Menu System Info

CAUTION: Changes within the Installation Menu can affect proper operation and should be performed by qualified personnel

NOTE: Diagram shows UNO-S2 keypad buttons used in the programming procedure.
Corresponding UNO-S1 keypad buttons:

UNO-S1:  UNO-S2: 

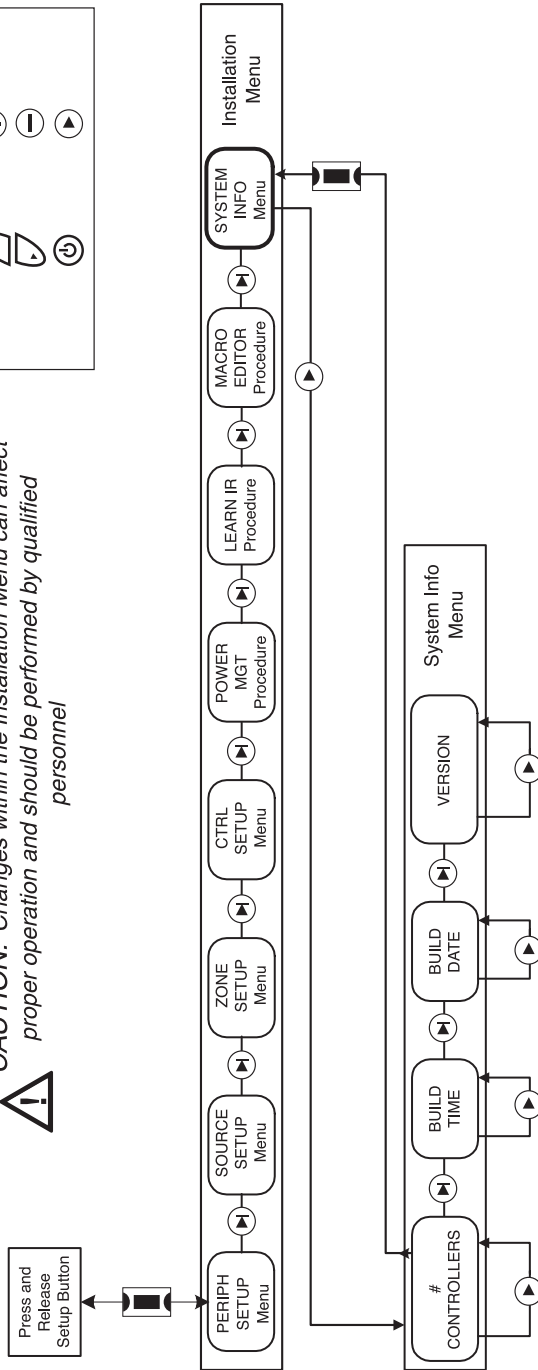

INSTALLER KEYPAD DIAGNOSTIC MENU

UNO Keypad Diagnostics Menu

The Diagnostics Menu allows the installer to run a diagnostic check on the keypad and to verify the firmware version. The Diagnostics Menu also contains the update firmware procedure for updating the UNO-S1 and UNO-S2's firmware.

To access the Diagnostics Menu, press and hold the Setup button on the right side of the keypad until "DIAGNOSTICS" appears on the display. The menus are outlined in the diagram below.

When finished, press and release the Setup button again (except for the Update Firmware where the power must be cycled).

Note: Do not change Controller ID settings in this menu. Controller ID is set in the Controller Setup menu (see **Controller Setup Menu on page 72**).

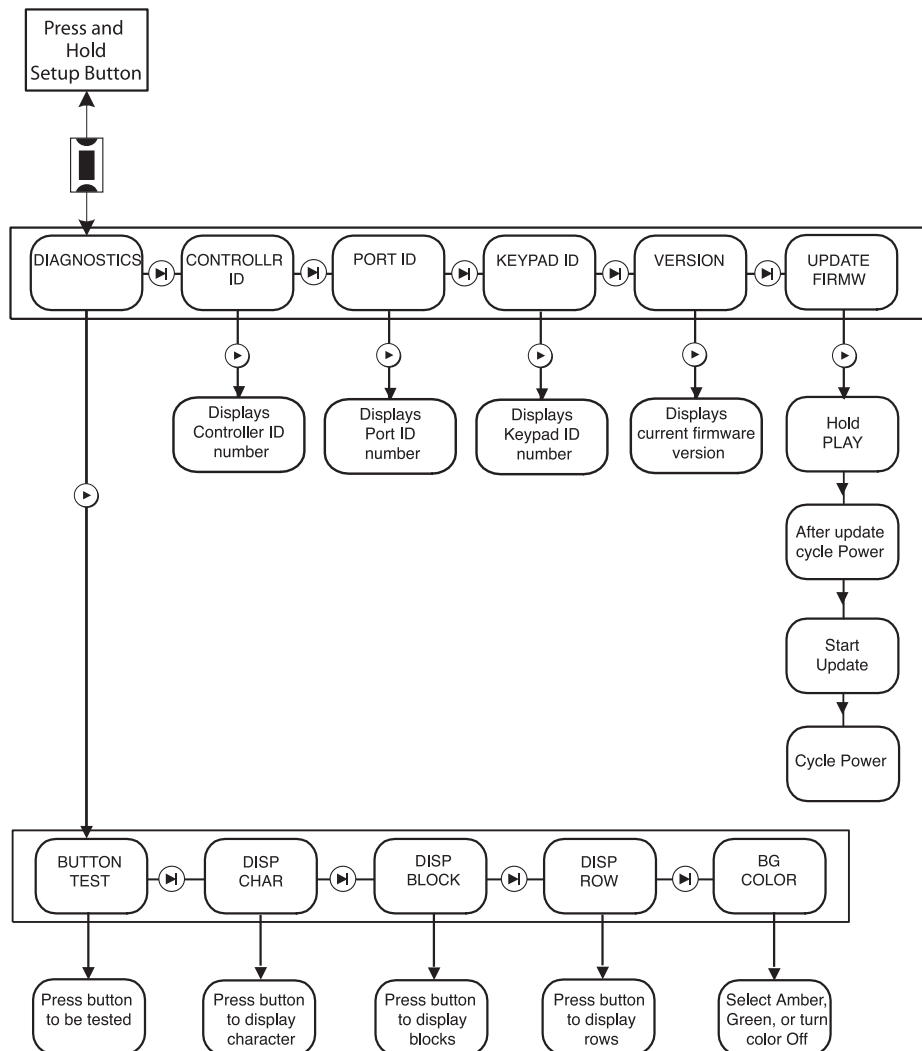

INSTALLER

IR DEVICE CODES

Device Codes for TVs:

Admiral	0093, 0463
Advent	0761, 0842
Aiko	0092
Akai	0030, 0672, 0702, 0812
Albatron	0700, 0843
America Action	0180
Anam	0180
AOC	0030
Apex Digital	0748, 0765, 0767, 0879, 1943
Audiovox	0451, 0180, 0092, 0623
Bell & Howell	0154
BenQ	1032
Bradford	0180
Broksonic	0236, 0463, 1935, 1911
Candle	0030
Carnivale	0030
Carver	0054
Celebrity	0000
Celera	0765
Changhong	0765
Citizen	0060, 0030, 0092
Clarion	0180
Comm'l Solutions	1447, 0047
Contec	0180
Craig	0180
Crosley	0054
Crown	0180
Curtis Mathes	0047, 1147, 1347, 0054, 0154, 0451, 0093, 0060, 0030, 0145, 0166, 0702
CXC	0180
Daewoo	0451, 1661, 0672, 0092, 0661, 0623
Dell	1080
Denon	0145
Dumont	0017
Durabrand	0463, 0180, 0178, 0171, 1034
Electroband	0000
Emerson	0154, 0236, 0463, 0180, 0178, 0171, 1911, 0623
Envision	0030
ESA	0812, 0171
Fisher	0154
Fujitsu	0853, 0809, 0683
Funai	0180, 0171, 1904
Futuretech	0180
Gateway	1756, 1755
GE	1447, 0047, 1147, 1347, 0051, 0451, 0178, 1922, 1917
Gibraltar	0017, 0030
Go Video	0886
GoldStar	0030, 0178
Grunpy	0180
Haier	1034
Hallmark	0178
Harley Davidson	1904
Harman/Kardon	0054
Harvard	0180
Havermy	0093
Helios	0865
Hello Kitty	0451
Hisense	0748
Hitachi	1145, 0145, 1960, 1904
Hyundai	0849
Infinity	0054
Inteq	0017
JBL	0054
JCB	0000
Jensen	0761
JVC	0053, 1253, 1923, 0731
KEC	0180
Kenwood	0030
KLH	0765, 0767
KTV	0180, 0030
LG	0178, 0700, 0856
Lloyd's	1904
LXI	0047, 0054, 0154, 0156, 0178
Magnavox	1454, 0054, 0030, 0706, 1904, 1254
Marantz	0054, 0030
Matsushita	0250
Maxent	1755
Megapower	0700
Megatron	0178, 0145
Memorex	0154, 0463, 0150, 0178, 1911
MGA	0150, 0030, 0178
Midland	0047, 0017, 0051
Mitsubishi	0093, 1250, 0150, 0178, 1917
Monivision	0843, 0700
Motorola	0093
MTC	0060, 0030
Multitech	0180
NAD	0156, 0178, 0866
NEC	0030
Nikko	0030, 0178, 0092
Norcent	0748, 0824
NTC	0092
Onwa	0180
Optimus	0154, 0250, 0166
Optonica	0093
Orion	0236, 0463, 1911, 1463
Panasonic	0250, 0051, 1941
Penney	0047, 0156, 0051, 0060, 0030, 0178, 1347
Philco	0054, 0030
Philips	1454, 0054, 1961, 0690
Pilot	0030
Pioneer	0166, 0679, 0866
Portland	0092
Prima	0761
Princeton	0700
Prism	0051
Proscan	1447, 0047, 1347, 1922
Proton	0178
Pulsar	0017
Quasar	0250, 0051
Radio Shack	0047, 0154, 0180, 0030, 0178, 1904
RCA	1447, 0047, 1047, 1347, 1917, 0679, 1247, 1547, 1948, 0090, 1147, 1922
Realistic	0154, 0180, 0030, 0178
Runco	0017, 0030
Sampo	0030, 1755
Samsung	0060, 0812, 0702, 0030, 0178, 0766, 1959, 1060
Sansul	0463, 1935, 1911, 1904
Sanyo	0154, 0088
Scotch	0178
Scott	0236, 0180, 0178
Sears	0047, 0054, 0154, 0156, 0178, 0171, 1904
Sharp	0093, 1917
Sheng Chia	0093
Sony	1100, 0000, 1904
Soundesign	0180, 0178
Squareview	0171
SSS	0180
Starlite	0180
Studio Experience	0843
Supreme	0000
SVA	0748, 0865
Sylvania	0054, 0030, 0171
Symphonic	0180, 0171, 1904
Tandy	0093
Tatung	1756
Technics	0051, 0250
Techwood	0051
Teknika	0054, 0180, 0150, 0060, 0092
Telefunken	0702
Thomas	1904
TMK	0178
TNCi	0017
Toshiba	0154, 0156, 0060, 1256, 1156, 1656, 1356, 1945, 1935
TVS	0463
V Inc.	1756
Vector Research	0030
Victor	0053
Vidikron	0054
Vidtech	0178
Viewsonic	1755
Wards	0054, 0030, 0178, 0866, 1156
Waycon	0156
Westinghouse	0889
WhiteWestinghouse	0463, 0623
Yamaha	0030
Zenith	0017, 0463, 0178, 1911, 0092, 1904

Device Codes for Cable:

ABC	0003, 0008
Americast	0899
Bell South	0899
Clearmaster	0883
ClearMax	0883
Coolmax	0883
Director	0476
General Instrument	0003, 0476, 0810, 0276
GoldStar	0144
Hamlin	0009, 0273
Jerrold	0003, 0276, 0476, 0810
Memorex	0000
Motorola	0476, 0276, 0810, 1254, 1376
Multitech	0883
Pace	0237, 1877
Panasonic	0000, 0107
Paragon	0000
Philips	0317, 1305
Pioneer	0144, 0533, 0877, 1877
Pulsar	0000
Quasar	0000
RadioShack	0883
Regal	0273, 0279
Runco	0000
Samsung	0144
Scientific Atlanta	0008, 0477, 0877, 1877
Sony	1006

(continued next page)

INSTALLER IR DEVICE CODES

Device Codes for Cable: (cont'd)

Starcom	0003
Supercable	0276
Supermax	0883
Torx	0003
Toshiba	0000
Tristar	0883
V2	0883
Viewmaster	0883
Vision	0883
Vortex View	0883
Zenith	0000, 0525, 0899

Device Codes for Video Acc:

ABS	1272
Alienware	1272
CyberPower	1272
D-Link	1554
Escent	1151, 1371, 1370, 1373, 1372
Gateway	1272
Hewlett Packard	1272, 1267
Howard Computers	1272
iBUYPOWER	1272
LG	1415
Linksys	1365
Media Center PC	1272
Microsoft	1272
Mind	1272
Motorola	1363
Northgate	1272
Panasonic	1120
Pioneer	1010
Samsung	1190, 1490
Sensory Science	1126
Sharp	1010
SMC	1456
Sony	1272, 1324, 1364
Systemax	1272
Tagar Systems	1272
Toshiba	1272
Touch	1272
Viewsonic	1272, 1329
ZT Group	1272

Device Codes for SAT/DSS:

AlphaStar	0772
Century	0856
Chaparral	0216
Crossdigital	1109
DirecTV	0392, 0566, 0639, 1639, 1142, 0247, 0749, 1749, 0724, 0819, 1856, 1076, 1109, 0099, 1640, 1108, 1392, 1442, 1414
Dish Network Sys	1005, 0775, 1775, 1505
Dishpro	1005, 0775, 1505, 1775
Echostar	1005, 0775, 1775, 1505
Expressvu	0775, 1775
GE	0566
General Instrument	0869
GOI	0775, 1775
Hisense	1535

Hitachi	0819, 1250
HTS	0775, 1775
Hughes Net. Sys.	0749, 1142, 1749, 1442
H.o	1535
JVC	0775, 1775
LG	1414
Magnavox	0724, 0722
Memorex	0724
Mitsubishi	0749
Motorola	0869
Next Level	0869
Panasonic	0247, 0701
Paysat	0724
Philips	1142, 0749, 1749, 0724, 1076, 0722, 0099, 1442, 0856
Proscan	0392, 0566
Proton	1535
RadioShack	0869
RCA	0392, 0566, 0143, 0855, 1392
Samsung	1276, 1109, 1108
Sony	0639, 1639, 1640
Star Choice	0869
Tivo	1142, 1442
Toshiba	0749, 1749, 0790, 1285
UltimateTV	1392, 1640
Uniden	0724, 0722
US Digital	1535
USDTV	1535
Voom	0869
Zenith	0856, 1856

Device Codes for VCRs:

ABS	1972
Admiral	0048, 0209
Adventura	0000
Aiko	0278
Alwa	0037, 0000
Akai	0041
Alienware	1972
America Action	0278
American High	0035
Asha	0240
Audiovox	0037, 0278
Beaumarck	0240
Bell & Howell	0104
Broksonic	0184, 0121, 0209, 0002, 0479
Calix	0037
Canon	0035
Carver	0081
CCE	0072, 0278
Citizen	0037, 0278
Colt	0072
Craig	0037, 0047, 0240, 0072
Curtis Mathes	0060, 0035, 0162, 0041
Cybernex	0240
CyberPower	1972
Daewoo	0045, 0278
Dell	1972
Denon	0042
DirecTV	0739
Durabrand	0039, 0038
Dynatech	0000
Electrohome	0037
Electrohome	0037
Emerex	0032

Emerson	0037, 0184, 0000, 0121, 0043, 0209, 0002, 0278, 0479
Fisher	0047, 0104
Fuji	0035, 0033
Funai	0000
Garrard	0000
Gateway	1972
GE	0035, 0060, 0240
Go Video	0432
GoldStar	0037, 0038
Gradiente	0000
Harley Davidson	0000
Harman/Kardon	0081, 0038
Harwood	0072
Hewlett Packard	1972
Hi-Q	0047
Hitachi	0000, 0042, 0041, 0089
Howard Computers	1972
Hughes Net. Sys.	0042, 0739
iBUYPOWER	1972
Jensen	0041
JVC	0067, 0041
KEC	0037, 0278
Kenwood	0067, 0041, 0038
KLH	0072
Kodak	0035, 0037
Lloyd's	0000
Logik	0072
LXI	0037
Magnavox	0035, 0039, 0081, 0000, 0149
Magnin	0240
Marantz	0035, 0081
Marta	0037
Matsushita	0035, 0162
Media Center PC	1972
MEI	0035
Memorex	0035, 0162, 0037, 0048, 0039, 0047, 0240, 0000, 0104, 0209, 0479
MGA	0240, 0043
MGN Technology	0240
Microsoft	1972
Mind	1972
Minolta	0042
Mitsubishi	0067, 0043
Motorola	0035, 0048
MTC	0240, 0000
Multitech	0000, 0072
NEC	0104, 0067, 0041, 0038
Nikko	0037
Noblex	0240
Northgate	1972
Olympus	0035
Optimus	1062, 0162, 0037, 0048, 0104, 0432
Orion	0184, 0209, 0002, 0479
Panasonic	1062, 0035, 0162, 0225, 0616
Penney	0035, 0037, 0240, 0042, 0038
Pentax	0042
Philco	0035
Philips	0035, 0081, 0618, 0739
Pilot	0037
Pioneer	0067
Polk Audio	0081
Profitronic	0240
Proscan	0060
Protec	0072

(continued next page)

INSTALLER

IR DEVICE CODES

Device Codes for VCRs: (cont'd)

Pulsar	0039
Quasar	0035, 0162
Radio Shack	0000
Radix	0037
Randex	0037
RCA	0060, 0240, 0042, 0149, 0880
Realistic	0035, 0037, 0048, 0047, 0000, 0104
ReplayTV	0616
Runco	0039
Samsung	0045, 0240
Sanky	0048, 0039
Sansui	0000, 0067, 0209, 0041, 0479
Sanyo	0047, 0240, 0104
Scott	0184, 0045, 0121, 0043
Sears	0035, 0037, 0047, 0000, 0042, 0104
Sharp	0048
Shintom	0072
Shogun	0240
Singer	0072
Sonic Blue	0616
Sony	0035, 0032, 0033, 0000, 0636, 1972
STS	0042
Sylvania	0035, 0081, 0000, 0043
Symphonic	0000
Systemax	1972
Tagar Systems	1972
Tatung	0041
Teac	0000, 0041
Technics	0035, 0162
Teknika	0035, 0037, 0000
Thomas	0000
Tivo	0618, 1503, 0739, 0636
TMK	0240
Toshiba	0045, 0043, 1008, 1972, 1503
Totevision	0037, 0240
Touch	1972
Unitech	0240
Vector	0045
Vector Research	0038
Video Concepts	0045
Videomagic	0037
Videosonic	0240
Viewsonic	1972
Villain	0000
Wards	0035, 0060, 0048, 0047, 0081, 0000, 0042, 0240, 0072, 0149
White Westinghouse	0209, 0072
XR-1000	0035, 0000, 0072
Yamaha	0038
Zenith	0039, 0033, 0000, 0209, 0479
ZT Group	1972

Device Codes for Laser Disc Players:

Denon	0059
Mitsubishi	0059
NAD	0059
Optimus	0059
Panasonic	0204

Pioneer	0059
Quasar	0204
Sony	0201
Technics	0204

Device Codes for DVD Players:

Allegro	0869
Apex Digital	0672, 0717, 0797, 1061, 0796, 1056, 0794, 1020
Aspire Digital	1168
Blaupunkt	0717
Blue Parade	0571
Broksonic	0695
CineVision	0869
Coby	1086
CyberHome	0816, 1129
Daewoo	0784, 0833, 1172, 0869
Denon	0490
DVD2000	0521
Emerson	0591, 0675
Enterprise	0591
Fisher	0670
Funai	0675
Gateway	1073, 1194, 1158, 1077
GE	0522, 0717
Go Video	0744, 0715, 0833, 1099, 0783, 1075, 1730, 0869, 1158
Greenhill	0717
Hitachi	0573, 0664
Hiteker	0672
Initial	0717
JVC	0558, 0623, 0867
Kenwood	0490, 0534
KLH	0717, 1020
Koss	0651
Lasonic	0798
LG	0591, 0869
Lite-On	1158, 1058
Magnavox	0503, 0539, 0675
Marantz	0539
Memorex	0695
Microsoft	0522
Mintek	0839, 0717
Mitsubishi	1521, 0521
Nesa	0717
Onkyo	0503
Oritron	0651
Panasonic	0490, 1762
Philips	0503, 0539, 0646, 0675, 0885
Pioneer	0525, 0571
Polaroid	1086, 1061
Polk Audio	0539
Proscan	0522
Qwestar	0651
RCA	0522, 0571, 0717, 0822
Rio	0869
Rotel	0623
Sampo	0752
Samsung	0490, 0573, 1075, 0820
Sansui	0695
Sanyo	0695, 0670, 0873
Sharp	0630, 0752
Sherwood	1077
Shinsonic	0533, 0839
Sonic Blue	0869, 1099

Sony	0533, 0864, 1033
Sylvania	0675
Symphonic	0675
Technics	0490
Theta Digital	0571
Toshiba	0503, 1154, 0695
Urban Concepts	0503
US Logic	0839
Xbox	0522
Yamaha	0490, 0539, 0545
Zenith	0503, 0591, 0869

Device Codes for Tuner/Amp:

ADC	0531
Aiwa	0189, 1405, 0158, 0121
Anam	1609, 1074
Audiotronic	1189
Bose	1229
Capetronic	0531
Carver	0189, 1189
Coby	1263
Dell	1383
Denon	1360, 1142
Gateway	1517
Glory Horse	1263
Harman/Kardon	0110, 0189
Hewlett Packard	1181
Integra	0135
JBL	0110
JVC	0074, 1263
Kenwood	1313, 1569, 0027
KLH	1428
Linn	0189
Magnavox	1189, 1269, 0189, 0531
Marantz	1189, 1269, 0039, 0189
MCS	0039
Mitsubishi	1393
Onkyo	0135
Optimus	1023, 0670, 0531, 1074
Panasonic	0039, 0309
Philips	1189, 1269, 0189
Pioneer	1023, 0150, 0014, 0630, 0531
Polk Audio	0189
Proscan	1254
Quasar	0039
RadioShack	1263
RCA	1023, 1609, 1254, 1074, 0531
Rio	1383
Sansui	0189
Sharper Image	1263
Sonic Blue	1383
Sony	1058, 1759, 0158, 1406
Soundesign	0670
Stereophonics	1023
Sunfire	1313
Teac	1074
Technics	1308, 0039, 0309
Thorens	1189
Victor	0074
Wards	0158, 0189, 0014
Yamaha	0176, 1276, 1176

INSTALLER IR DEVICE CODES

Device Codes for Amp and Misc. Audio:

Aiwa	0159
Altec Lansing	1485
Cambridge Sound	1530
Creative	0872
Durabrand	1561
GE	0078
Harman/Kardon	0892
JVC	0331
Left Coast	0892
Lennox	1561
Marantz	0892, 1491
Motorola	1464
Omnifi	1605
Optimus	0395
Philips	0892
Polk Audio	0892
Realistic	0395
Russound	1302
Sony	0159
Soundesign	0078
Victor	0331
Wards	0078
Yamaha	0354

QED	0157
Quad	0157
Quasar	0029
RadioShack	1075
RCA	0032, 0305, 0179, 0053, 0420
Realistic	0420, 0179
Rotel	0157, 0420
SAE	0157
Sansui	0157, 0305
Sanyo	0087, 0179
Scott	0305
Sears	0305
Sharp	0861, 0037
Sherwood	1067
Sonic Frontiers	0157
Sony	0490, 0000, 0100
Soundesign	0145
Symphonic	0305
TAG McLaren	0157
Tascam	0420
Teac	0420
Technics	0029
Victor	0072
Wards	0157, 0053
Yamaha	0888, 0036

Device Codes for CD Players:

Aiwa	0157
Burmester	0420
Calif. Audio Labs	0029
Carver	0157, 0179
Denon	0873, 0003
DKK	0000
DMX Electronics	0157
Emerson	0305
Fisher	0179
Garrard	0420
Genexxa	0032, 0305
Harman/Kardon	0157, 0173
Hitachi	0032
Integra	0101
JVC	0072
Kenwood	0681, 0028, 0037, 0190
KLH	1318
Krell	0157
Linn	0157
LXI	0305
Magnavox	0157, 0305
Marantz	0029, 0157
MCS	0029
Miro	0000
Mission	0157
MTC	0420
NSM	0157
Onkyo	0868, 0101
Optimus	1063, 0000, 0032, 0037, 1075, 0179, 0145, 0420, 0087, 0305
Panasonic	0029
Parasound	0420
Philips	0157
Pioneer	1063, 0032, 0305
Polk Audio	0157
Proton	0157

Device Codes for Home Control:

Accutek	1215
Bionaire	1215
Frigidaire	1333
GE	0240
GoldStar	1537
Holmes	1215
Lasko	0846
LG	1537
Lutron	0597
One For All	0167
RadioShack	0240
Russound	1232, 1233
Security System	0167
Sharper Image	0846
Universal X10	0167
Whirlpool	1332
Windmere	1215
X10	0167

INSTALLER KEY CODES TV (HDTV)

KEY FUNCTION	UNO-S1	TV (HDTV)	KEY FUNCTION	UNO-S1	TV (HDTV)
1	1	Digit 1	Pause	Pause	Learned Only
2	2	Digit 2	Record	Recrd	Learned Only
3	3	Digit 3	Menu	Menu	Menu (Picture)
4	4	Digit 4	Menu Up	MenuU	Menu Up, Adjust Up
5	5	Digit 5	Menu Dn	MenuD	Menu Dn, Adjust Dn
6	6	Digit 6	Menu Left	MenuL	Menu Left
7	7	Digit 7	Menu Right	MenuR	Menu Right
8	8	Digit 8	Select	Sel	Menu Select
9	9	Digit 9	Exit	Exit	Exit, Cancel
0	0	Digit 0	Display	Displ	Display, OSD, Info
Volume Up	VolUp	Volume Up	Guide	Guide	Guide
Volume Down	VolDn	Volume Down	Page Up	PageU	Adjust up
Mute	Mute	Mute	Page Down	PageD	Adjust Down
Channel Up	Ch Up	Channel Up	Disk	Disk	Learned Only
Channel Dn	Ch Dn	Channel Down	Plus 10	Pls10	+100
Power	Power	Power On/Off	Open/Close	Op/Cl	Learned Only
Enter	Enter	Channel Enter	Random	Randm	Learned Only
Prev Channel	PrvCh	Last Channel	Track Fwd	TkFwd	Learned Only
TV/Video	TVVid	Learned Only	Track Rev	TkRev	Learned Only
TV/VCR	TVVCR	Learned Only	Sur On/Off	SurOn	Surround On/Off
A/B	A / B	Learned Only	Sur Mode	SurMd	Learned Only
TV/DVD	TVDVD	Learned Only	Surround Up	SurUp	Learned Only
TV/LD	TV LD	Learned Only	Surround Dn	SurDn	Learned Only
Input	Input	TV/Video	PIP	PIP	Learned Only
TV/DSS	TVDSS	Learned Only	PIP Move	PIP M	PIP Move
Play	Play	Learned Only	PIP Swap	PIP S	PIP Swap
Stop	Stop	Learned Only	Program	Progm	Learned Only
Search Fwd	SrchF	Learned Only	Sleep	Sleep	Learned Only
Search Rev	SrchR	Learned Only	On	On	On, Power On/Off

INSTALLER KEY CODES TV (HDTV)

KEY FUNCTION	UNO-S1	TV (HDTV)
Off	Off	Off, Power On/Off
11	11	Learned Only
12	12	Learned Only
13	13	Learned Only
14	14	Learned Only
15	15	Learned Only
16	16	Learned Only
Bright	Brght	Learned Only
Dim	Dim	Learned Only
Close	Close	Learned Only
Open	Open	Learned Only
Halt	Halt	Learned Only
AM/FM	AM/FM	Learned Only
Cue	Cue	Learned Only
Disk Up	DiskU	Learned Only
Disk Down	DiskD	Learned Only
Info	Info	Learned Only
External Src	ExtSr	External Antenna
Live/Intro	Intro	Learned Only
Menu	Menu	Menu (Audio)
Back	Back	Back
Fav Channel	FavCh	Favorite
Display Fmt	DFrmt	Fmt,Wide,16:9,Aspct
SAP	SAP	SAP, CC
Slow	Slow	Learned Only
PIP On	PIPOn	PIP ON
PIP Off	PIPOf	PIP OFF
PIP Freeze	PIPFr	PIP Freeze
PIP Input	PIPIIn	PIP Input

KEY FUNCTION	UNO-S1	TV (HDTV)
PIP Chan Up	PIPCU	PIP Channel Up
PIP Chan Dn	PIPcD	PIP Channel Down
Input 1	In 1	VID1,Video,TVp1
Input 2	In 2	VID2,TVp2
Input 3	In 3	VID3,TVp3
Input 4	In 4	VID4,TVp4
Input 5	In 5	VID5,AV1,VCR,BNC
Input 6	In 6	VID6,AV2,VDR,DVD,DVI
Input 7	In 7	TV, Component
Input 8	In 8	CAB,SAT,S-Video
Input 9	In 9	AV, Tuner
Input 10	In 10	AUX, RGB

INSTALLER KEY CODES CABLE

KEY FUNCTION	UNO-S1	CABLE
1	1	Digit 1
2	2	Digit 2
3	3	Digit 3
4	4	Digit 4
5	5	Digit 5
6	6	Digit 6
7	7	Digit 7
8	8	Digit 8
9	9	Digit 9
0	0	Digit 0
Volume Up	VolUp	Volume Up
Volume Down	VolDn	Volume Down
Mute	Mute	Mute
Channel Up	Ch Up	Channel Up
Channel Dn	Ch Dn	Channel Down
Power	Power	Power On/Off
Enter	Enter	Channel Enter
Prev Channel	PrvCh	Last Channel
TV/Video	TVVid	Learned Only
TV/VCR	TVVCR	Learned Only
A/B	A / B	Learned Only
TV/DVD	TVDVD	Learned Only
TV/LD	TV LD	Learned Only
Input	Input	Bypass, A/B
TV/DSS	TVDSS	Learned Only
Play	Play	Play
Stop	Stop	Stop
Search Fwd	SrchF	Fast Forward
Search Rev	SrchR	Rewind

KEY FUNCTION	UNO-S1	CABLE
Pause	Pause	Pause
Record	Recrd	Record
Menu	Menu	Menu, Settings
Menu Up	MenuU	Menu Up
Menu Dn	MenuD	Menu Down
Menu Left	MenuL	Menu Left
Menu Right	MenuR	Menu Right
Select	Sel	Menu Select
Exit	Exit	Exit, Cancel
Display	Displ	Info, Display, OSD
Guide	Guide	Guide
Page Up	PageU	Page Up
Page Down	PageD	Page Down
Disk	Disk	Learned Only
Plus 10	Pls10	+100
Open/Close	Op/Cl	Learned Only
Random	Randm	Learned Only
Track Fwd	TkFwd	Quick Skip,Advance
Track Rev	TkRev	Instant Replay
Sur On/Off	SurOn	Day Down
Sur Mode	SurMd	Learned Only
Surround Up	SurUp	Learned Only
Surround Dn	SurDn	Learned Only
PIP	PIP	Learned Only
PIP Move	PIP M	Learned Only
PIP Swap	PIP S	Learned Only
Program	Progm	Learned Only
Sleep	Sleep	Learned Only
On	On	On, Power On/Off

INSTALLER KEY CODES CABLE

KEY FUNCTION	UNO-S1	CABLE
Off	Off	Off, Power On/Off
11	11	Learned Only
12	12	Learned Only
13	13	Learned Only
14	14	Learned Only
15	15	Learned Only
16	16	Learned Only
Bright	Brght	Learned Only
Dim	Dim	Learned Only
Close	Close	Learned Only
Open	Open	Learned Only
Halt	Halt	Learned Only
AM/FM	AM/FM	Learned Only
Cue	Cue	Learned Only
Disk Up	DiskU	Learned Only
Disk Down	DiskD	Learned Only
Info	Info	Learned Only
External Src	ExtSr	External AV Source
Live/Intro	Intro	Return to Live
Menu	Menu	PPV (Wink)
Back	Back	Back
Fav Channel	FavCh	Favorite
Display Fmt	DFrmt	Help
SAP	SAP	Day Up
Slow	Slow	Learned Only
PIP On	PIPOn	Learned Only
PIP Off	PIPOf	Learned Only
PIP Freeze	PIPFr	Learned Only
PIP Input	PIPIIn	Learned Only

KEY FUNCTION	UNO-S1	CABLE
PIP Chan Up	PIPcU	Learned Only
PIP Chan Dn	PIPcD	Learned Only
Input 1	In 1	A,VID1,Video,TVp1
Input 2	In 2	B,VID2,TVp2
Input 3	In 3	C,VID3,TVp3
Input 4	In 4	VID4,TVp4
Input 5	In 5	VID5,AV1,VCR,BNC
Input 6	In 6	VID6,AV2,VDP,DVD,DVI
Input 7	In 7	TV, Component
Input 8	In 8	CAB,SAT,S-Video
Input 9	In 9	AV, Tuner
Input 10	In 10	AUX, RGB

INSTALLER

KEY CODES

VIDEO ACC

KEY FUNCTION	UNO-S1	VIDEO ACC	KEY FUNCTION	UNO-S1	VIDEO ACC
1	1	Digit 1	Pause	Pause	Pause
2	2	Digit 2	Record	Recrd	Record
3	3	Digit 3	Menu	Menu	Menu, Home
4	4	Digit 4	Menu Up	MenuU	Menu Up
5	5	Digit 5	Menu Dn	MenuD	Menu Dn
6	6	Digit 6	Menu Left	MenuL	Menu Left
7	7	Digit 7	Menu Right	MenuR	Menu right
8	8	Digit 8	Select	Sel	Menu Select
9	9	Digit 9	Exit	Exit	Exit, Cancel, Go
0	0	Digit 0	Display	Displ	Info, Display, OSD
Volume Up	VolUp	Volume Up	Guide	Guide	Guide, View
Volume Down	VolDn	Volume Down	Page Up	PageU	Page Up, Scroll Up
Mute	Mute	Mute	Page Down	PageD	Page Dn, Scroll Dn
Channel Up	Ch Up	Channel Up	Disk	Disk	Learned Only
Channel Dn	Ch Dn	Channel Down	Plus 10	Pls10	+100. +10
Power	Power	Power On/Off	Open/Close	Op/Cl	Learned Only
Enter	Enter	Channel Enter	Random	Randm	Learned Only
Prev Channel	PrvCh	Last Channel	Track Fwd	TkFwd	Skip Up, Next
TV/Video	TVVid	Learned Only	Track Rev	TkRev	Skip Dn, Previous
TV/VCR	TVVCR	Learned Only	Sur On/Off	SurOn	Learned Only
A/B	A / B	Learned Only	Sur Mode	SurMd	Learned Only
TV/DVD	TVDVD	Learned Only	Surround Up	SurUp	Learned Only
TV/LD	TV LD	Learned Only	Surround Dn	SurDn	Learned Only
Input	Input	TV/Video, DTV	PIP	PIP	Learned Only
TV/DSS	TVDSS	Learned Only	PIP Move	PIP M	PIP Move
Play	Play	Play	PIP Swap	PIP S	PIP Swap
Stop	Stop	Stop	Program	Progm	Learned Only
Search Fwd	SrchF	Fast Forward	Sleep	Sleep	Learned Only
Search Rev	SrchR	Rewind	On	On	On, Power On/Off

INSTALLER KEY CODES VIDEO ACC

KEY FUNCTION	UNO-S1	VIDEO ACC	KEY FUNCTION	UNO-S1	VIDEO ACC
Off	Off	Off, Power On/Off	PIP Chan Up	PIP CU	PIP Channel Up
11	11	Learned Only	PIP Chan Dn	PIP CD	PIP Channel Down
12	12	Learned Only	Input 1	In 1	VID1,Video,TVp1
13	13	Learned Only	Input 2	In 2	VID2,TVp2
14	14	Learned Only	Input 3	In 3	VID3,TVp3
15	15	Learned Only	Input 4	In 4	VID4,TVp4
16	16	Learned Only	Input 5	In 5	VID5,AV1,VCR,BNC
Bright	Brght	Learned Only	Input 6	In 6	VID6,AV2,VDP,DVD,DVI
Dim	Dim	Learned Only	Input 7	In 7	TV, Component
Close	Close	Learned Only	Input 8	In 8	CAB,SAT,S-Video
Open	Open	Learned Only	Input 9	In 9	AV, Tuner
Halt	Halt	Learned Only	Input 10	In 10	AUX, RGB
AM/FM	AM/FM	Learned Only			
Cue	Cue	Learned Only			
Disk Up	DiskU	Learned Only			
Disk Down	DiskD	Learned Only			
Info	Info	Learned Only			
External Src	ExtSr	Ext. Antenna, Web			
Live/Intro	Intro	Learned Only			
Menu	Menu	Setup,Prgrm,Options			
Back	Back	Learned Only			
Fav Channel	FavCh	Favorites			
Display Fmt	DFrmt	Fmt,Wide,16:9,Aspct			
SAP	SAP	Language, MTS			
Slow	Slow	Learned Only			
PIP On	PIPOn	PIP ON			
PIP Off	PIPOf	PIP OFF			
PIP Freeze	PIPFr	PIP Freeze			
PIP Input	PIPIn	PIP Input			

INSTALLER

KEY CODES

SAT/DSS

KEY FUNCTION	UNO-S1	SAT/DSS	KEY FUNCTION	UNO-S1	SAT/DSS
1	1	Digit 1	Pause	Pause	Pause
2	2	Digit 2	Record	Recrd	Record
3	3	Digit 3	Menu	Menu	Menu (PVR, Tivo)
4	4	Digit 4	Menu Up	MenuU	Menu Up
5	5	Digit 5	Menu Dn	MenuD	Menu Down
6	6	Digit 6	Menu Left	MenuL	Menu Left
7	7	Digit 7	Menu Right	MenuR	Menu Right
8	8	Digit 8	Select	Sel	Menu Select
9	9	Digit 9	Exit	Exit	Exit, Cancel
0	0	Digit 0	Display	Displ	Info, Display, OSD
Volume Up	VolUp	Volume Up	Guide	Guide	Guide
Volume Down	VolDn	Volume Down	Page Up	PageU	Page Up, ThumbsUp
Mute	Mute	Mute	Page Down	PageD	Page Dn, ThumbsDn
Channel Up	Ch Up	Channel Up	Disk	Disk	Learned Only
Channel Dn	Ch Dn	Channel Down	Plus 10	Pls10	+100
Power	Power	Power On/Off	Open/Close	Op/Cl	Learned Only
Enter	Enter	Channel Enter	Random	Randm	Learned Only
Prev Channel	PrvCh	Last Channel	Track Fwd	TkFwd	Quick Skip, Advance
TV/Video	TVVid	Learned Only	Track Rev	TkRev	Instant Replay
TV/VCR	TVVCR	Learned Only	Sur On/Off	SurOn	Learned Only
A/B	A / B	Learned Only	Sur Mode	SurMd	Learned Only
TV/DVD	TVDVD	Learned Only	Surround Up	SurUp	Learned Only
TV/LD	TV LD	Learned Only	Surround Dn	SurDn	Learned Only
Input	Input	TV/DSS/SAT	PIP	PIP	Learned Only
TV/DSS	TVDSS	Learned Only	PIP Move	PIP M	Learned Only
Play	Play	Play	PIP Swap	PIP S	Learned Only
Stop	Stop	Stop	Program	Progm	Learned Only
Search Fwd	SrchF	Fast Forward	Sleep	Sleep	Learned Only
Search Rev	SrchR	Rewind	On	On	On, Power On/Off

INSTALLER KEY CODES SAT/DSS

KEY FUNCTION	UNO-S1	SAT/DSS	KEY FUNCTION	UNO-S1	SAT/DSS
Off	Off	Off, Power On/Off	PIP Chan Up	PIP CU	Learned Only
11	11	Learned Only	PIP Chan Dn	PIP CD	Learned Only
12	12	Learned Only	Input 1	In 1	VID1, Video, TVp1
13	13	Learned Only	Input 2	In 2	VID2, TVp2
14	14	Learned Only	Input 3	In 3	VID3, TVp3
15	15	Learned Only	Input 4	In 4	VID4, TVp4
16	16	Learned Only	Input 5	In 5	VID5, AV1, VCR, BNC
Bright	Brght	Learned Only	Input 6	In 6	VID6, AV2, VDR, DVD, DVI
Dim	Dim	Learned Only	Input 7	In 7	TV, Component
Close	Close	Learned Only	Input 8	In 8	CAB, SAT, S-Video
Open	Open	Learned Only	Input 9	In 9	AV, Tuner
Halt	Halt	Learned Only	Input 10	In 10	AUX, RGB
AM/FM	AM/FM	Learned Only			
Cue	Cue	Learned Only			
Disk Up	DiskU	Learned Only			
Disk Down	DiskD	Learned Only			
Info	Info	Learned Only			
External Src	ExtSr	External AV Source			
Live/Intro	Intro	Return to Live			
Menu	Menu	Menu (DTV)			
Back	Back	Back			
Fav Channel	FavCh	Favorite			
Display Fmt	DFrmt	Fmt, Wide, 16:9, Aspct			
SAP	SAP	Alt/Audio, Lang., CC			
Slow	Slow	Slow			
PIP On	PIPOn	Learned Only			
PIP Off	PIPOf	Learned Only			
PIP Freeze	PIPFr	Learned Only			
PIP Input	PIPIn	Learned Only			

INSTALLER

KEY CODES

VCR

KEY FUNCTION	UNO-S1	VCR	KEY FUNCTION	UNO-S1	VCR
1	1	Digit 1	Pause	Pause	Pause
2	2	Digit 2	Record	Recrd	Record
3	3	Digit 3	Menu	Menu	Menu (PVR,Tivo)
4	4	Digit 4	Menu Up	MenuU	Menu Up
5	5	Digit 5	Menu Dn	MenuD	Menu Down
6	6	Digit 6	Menu Left	MenuL	Menu Left
7	7	Digit 7	Menu Right	MenuR	Menu Right
8	8	Digit 8	Select	Sel	Menu Select
9	9	Digit 9	Exit	Exit	Exit, Cancel
0	0	Digit 0	Display	Displ	Display, OSD, Info
Volume Up	VolUp	Volume Up	Guide	Guide	Guide,VCR+,Prgrm
Volume Down	VolDn	Volume Down	Page Up	PageU	Thmubs Up
Mute	Mutte	Mute	Page Down	PageD	Thmubs Down
Channel Up	Ch Up	Channel Up	Disk	Disk	Learned Only
Channel Dn	Ch Dn	Channel Down	Plus 10	Pls10	+100
Power	Power	Power On/Off	Open/Close	Op/Cl	Learned Only
Enter	Enter	Channel Enter	Random	Randm	Learned Only
Prev Channel	PrvCh	Last Channel	Track Fwd	TkFwd	QuickSkip/Adv,Indx TrkUp
TV/Video	TVVid	Learned Only	Track Rev	TkRev	Instnt Rplay,Indx Trk Dn
TV/VCR	TVVCR	Learned Only	Sur On/Off	SurOn	Learned Only
A/B	A / B	Learned Only	Sur Mode	SurMd	Learned Only
TV/DVD	TVDVD	Learned Only	Surround Up	SurUp	Learned Only
TV/LD	TV LD	Learned Only	Surround Dn	SurDn	Learned Only
Input	Input	TV/VCR	PIP	PIP	Learned Only
TV/DSS	TVDSS	Learned Only	PIP Move	PIP M	Learned Only
Play	Play	Play	PIP Swap	PIP S	Learned Only
Stop	Stop	Stop	Program	Progm	Learned Only
Search Fwd	SrchF	Fast Forward	Sleep	Sleep	Learned Only
Search Rev	SrchR	Rewind	On	On	On, Power On/Off

INSTALLER KEY CODES VCR

KEY FUNCTION	UNO-S1	VCR	KEY FUNCTION	UNO-S1	VCR
Off	Off	Off, Power On/Off	PIP Chan Up	PIPCU	Learned Only
11	11	Learned Only	PIP Chan Dn	PIPCD	Learned Only
12	12	Learned Only	Input 1	In 1	VID1,Video,TVp1
13	13	Learned Only	Input 2	In 2	VID2,TVp2
14	14	Learned Only	Input 3	In 3	VID3,TVp3
15	15	Learned Only	Input 4	In 4	VID4,TVp4
16	16	Learned Only	Input 5	In 5	VID5,AV1,VCR,BNC
Bright	Brght	Learned Only	Input 6	In 6	VID6,AV2,VDP,DVD,DVI
Dim	Dim	Learned Only	Input 7	In 7	TV, Component
Close	Close	Learned Only	Input 8	In 8	CAB,SAT,S-Video
Open	Open	Learned Only	Input 9	In 9	AV, Tuner
Halt	Halt	Learned Only	Input 10	In 10	AUX, RGB
AM/FM	AM/FM	Learned Only			
Cue	Cue	Learned Only			
Disk Up	DiskU	Learned Only			
Disk Down	DiskD	Learned Only			
Info	Info	Learned Only			
External Src	ExtSr	Input Select			
Live/Intro	Intro	Return to Live,Auto Track			
Menu	Menu	Menu			
Back	Back	Clear			
Fav Channel	FavCh	Replay Zones, Indx Mark			
Display Fmt	DFrmt	Record Speed			
SAP	SAP	SAP, CC			
Slow	Slow	Slow			
PIP On	PIPOn	Learned Only			
PIP Off	PIPOf	Learned Only			
PIP Freeze	PIPFr	Learned Only			
PIP Input	PIPIn	Learned Only			

INSTALLER

KEY CODES

LASER DISC

KEY FUNCTION	UNO-S1	LASER DISC	KEY FUNCTION	UNO-S1	LASER DISC
1	1	Digit 1	Pause	Pause	Pause
2	2	Digit 2	Record	Recrd	Learned Only
3	3	Digit 3	Menu	Menu	Menu, Program
4	4	Digit 4	Menu Up	MenuU	Menu Up
5	5	5Digit 5	Menu Dn	MenuD	Menu Down
6	6	6Digit 6	Menu Left	MenuL	Menu Left
7	7	Digit 7	Menu Right	MenuR	Menu Right
8	8	Digit 8	Select	Sel	Menu Select
9	9	Digit 9	Exit	Exit	Exit, Cancel
0	0	Digit 0	Display	Displ	Display, OSD, Info
Volume Up	VolUp	Volume Up	Guide	Guide	Learned Only
Volume Down	VolDn	Volume Down	Page Up	PageU	Disk Skip, Disk Up
Mute	Mute	Mute	Page Down	PageD	Disk Down
Channel Up	Ch Up	Learned Only	Disk	Disk	Learned Only
Channel Dn	Ch Dn	Learned Only	Plus 10	Pls10	+10
Power	Power	Power On/Off	Open/Close	Op/Cl	Learned Only
Enter	Enter	Learned Only	Random	Randm	Learned Only
Prev Channel	PrvCh	Repeat	Track Fwd	TkFwd	Chapter/Skip Up
TV/Video	TVVid	Learned Only	Track Rev	TkRev	Chapter/Skip Down
TV/VCR	TVVCR	Learned Only	Sur On/Off	SurOn	Audio
A/B	A / B	Learned Only	Sur Mode	SurMd	Learned Only
TV/DVD	TVDVD	Learned Only	Surround Up	SurUp	Learned Only
TV/LD	TV LD	Learned Only	Surround Dn	SurDn	Learned Only
Input	Input	TV,LD,Input Select	PIP	PIP	Learned Only
TV/DSS	TVDSS	Learned Only	PIP Move	PIP M	Learned Only
Play	Play	Play	PIP Swap	PIP S	Learned Only
Stop	Stop	Stop	Program	Progm	Learned Only
Search Fwd	SrchF	Chapter/Skip Up	Sleep	Sleep	Learned Only
Search Rev	SrchR	Chapter/Skip Dn	On	On	On, Power On/Off

INSTALLER KEY CODES LASER DISC

KEY FUNCTION	UNO-S1	LASER DISC	KEY FUNCTION	UNO-S1	LASER DISC
Off	Off	Off, Power On/Off	PIP Chan Up	PIP CU	Learned Only
11	11	Learned Only	PIP Chan Dn	PIP CD	Learned Only
12	12	Learned Only	Input 1	In 1	VID1, Video, TVp1
13	13	Learned Only	Input 2	In 2	VID2, TVp2
14	14	Learned Only	Input 3	In 3	VID3, TVp3
15	15	Learned Only	Input 4	In 4	VID4, TVp4
16	16	Learned Only	Input 5	In 5	VID5, AV1, VCR, BNC
Bright	Brght	Learned Only	Input 6	In 6	VID6, AV2, VDR, DVD, DVI
Dim	Dim	Learned Only	Input 7	In 7	TV, Component
Close	Close	Learned Only	Input 8	In 8	CAB, SAT, S-Video
Open	Open	Learned Only	Input 9	In 9	AV, Tuner
Halt	Halt	Learned Only	Input 10	In 10	AUX, RGB
AM/FM	AM/FM	Learned Only			
Cue	Cue	Learned Only			
Disk Up	DiskU	Learned Only			
Disk Down	DiskD	Learned Only			
Info	Info	Learned Only			
External Src	ExtSr	Ext AV Src, CDV, VCD, Karaoke			
Live/Intro	Intro	Intro, Search, Scan			
Menu	Menu	Learned Only			
Back	Back	Learned Only			
Fav Channel	FavCh	Mark			
Display Fmt	DFrmt	Learned Only			
SAP	SAP	Subtitle, CC			
Slow	Slow	Slow			
PIP On	PIPOn	Learned Only			
PIP Off	PIPOf	Learned Only			
PIP Freeze	PIPFr	Learned Only			
PIP Input	PIPIn	Learned Only			

INSTALLER

KEY CODES

DVD

KEY FUNCTION	UNO-S1	DVD	KEY FUNCTION	UNO-S1	DVD
1	1	Digit 1, Track 1	Pause	Pause	Pause
2	2	Digit 2, Track 2	Record	Recrd	Record
3	3	Digit 3, Track 3	Menu	Menu	Disk Menu
4	4	Digit 4, Track 4	Menu Up	MenuU	Menu Up
5	5	Digit 5, Track 5	Menu Dn	MenuD	Menu Dn
6	6	Digit 6, Track 6	Menu Left	MenuL	Menu Left
7	7	Digit 7, Track 7	Menu Right	MenuR	Menu right
8	8	Digit 8, Track 8	Select	Sel	Menu Select
9	9	Digit 9, Track 9	Exit	Exit	Exit, Cancel, Return
0	0	Digit 0, Track 10	Display	Displ	Display, OSD, Info
Volume Up	VolUp	Volume Up	Guide	Guide	Title
Volume Down	VolDn	Volume Down	Page Up	PageU	Disk Skip, Disk Up
Mute	Mute	Mute	Page Down	PageD	Disk Down
Channel Up	Ch Up	Channel Up	Disk	Disk	Learned Only
Channel Dn	Ch Dn	Channel Down	Plus 10	Pls10	+100. +10
Power	Power	Power On/Off	Open/Close	Op/Cl	Learned Only
Enter	Enter	Channel Enter	Random	Randm	Learned Only
Prev Channel	PrvCh	Last Channel, Repeat	Track Fwd	TkFwd	Chapter/Skip Up
TV/Video	TVVid	Learned Only	Track Rev	TkRev	Chapter/Skip Down
TV/VCR	TVVCR	Learned Only	Sur On/Off	SurOn	Audio, Language
A/B	A / B	Learned Only	Sur Mode	SurMd	Learned Only
TV/DVD	TVDVD	Learned Only	Surround Up	SurUp	Learned Only
TV/LD	TV LD	Learned Only	Surround Dn	SurDn	Learned Only
Input	Input	TV/DVD, Input Select	PIP	PIP	Learned Only
TV/DSS	TVDSS	Learned Only	PIP Move	PIP M	Learned Only
Play	Play	Play	PIP Swap	PIP S	Learned Only
Stop	Stop	Stop	Program	Progm	Learned Only
Search Fwd	SrchF	Fast Forward	Sleep	Sleep	Learned Only
Search Rev	SrchR	Rewind	On	On	On, Power On/Off

INSTALLER KEY CODES DVD

KEY FUNCTION	UNO-S1	DVD	KEY FUNCTION	UNO-S1	DVD
Off	Off	Off, Power On/Off	PIP Chan Up	PIP CU	Learned Only
11	11	Learned Only	PIP Chan Dn	PIP CD	Learned Only
12	12	Learned Only	Input 1	In 1	VID1,Video,TVp1
13	13	Learned Only	Input 2	In 2	VID2,TVp2
14	14	Learned Only	Input 3	In 3	VID3,TVp3
15	15	Learned Only	Input 4	In 4	VID4,TVp4
16	16	Learned Only	Input 5	In 5	VID5,AV1,VCR,BNC
Bright	Brght	Learned Only	Input 6	In 6	VID6,AV2,VDP,DVD,DVI
Dim	Dim	Learned Only	Input 7	In 7	TV, Component
Close	Close	Learned Only	Input 8	In 8	CAB,SAT,S-Video
Open	Open	Learned Only	Input 9	In 9	AV, Tuner
Halt	Halt	Learned Only	Input 10	In 10	AUX, RGB
AM/FM	AM/FM	Learned Only			
Cue	Cue	Learned Only			
Disk Up	DiskU	Learned Only			
Disk Down	DiskD	Learned Only			
Info	Info	Learned Only			
External Src	ExtSr	External AV Source			
Live/Intro	Intro	Intro,Search,Scan			
Menu	Menu	Setup Menu			
Back	Back	Clear			
Fav Channel	FavCh	Mark			
Display Fmt	DFrmt	Format Wide,Zoom,Aspect			
SAP	SAP	Subtitle, CC			
Slow	Slow	Slow			
PIP On	PIPOn	Learned Only			
PIP Off	PIPOf	Learned Only			
PIP Freeze	PIPFr	Learned Only			
PIP Input	PIPIn	Learned Only			

INSTALLER

KEY CODES

RECEIVER

KEY FUNCTION	UNO-S1	RECEIVER	KEY FUNCTION	UNO-S1	RECEIVER
1	1	Digit 1	Pause	Pause	Pause
2	2	Digit 2	Record	Recrd	Record
3	3	Digit 3	Menu	Menu	Disk menu, Menu
4	4	Digit 4	Menu Up	MenuU	Menu Up, Adjust Up
5	5	Digit 5	Menu Dn	MenuD	Menu Dn, Adjust Dn
6	6	Digit 6	Menu Left	MenuL	Menu Left
7	7	Digit 7	Menu Right	MenuR	Menu Right
8	8	Digit 8	Select	Sel	Menu Select, Continue
9	9	Digit 9	Exit	Exit	Exit, Cancel
0	0	Digit 0	Display	Displ	Display, OSD, Info
Volume Up	VolUp	Volume Up	Guide	Guide	Title
Volume Down	VolDn	Volume Down	Page Up	PageU	Adjust Up
Mute	Mute	Mute	Page Down	PageD	Adjust Down
Channel Up	Ch Up	Preset Up	Disk	Disk	Learned Only
Channel Dn	Ch Dn	Preset Down	Plus 10	Pls10	Band, FM/AM
Power	Power	Power On/Off	Open/Close	Op/Cl	Learned Only
Enter	Enter	5.1, Prologic	Random	Randm	Random
Prev Channel	PrvCh	Last Channel, Repeat	Track Fwd	TkFwd	Skip Up
TV/Video	TVVid	Learned Only	Track Rev	TkRev	Skip Down
TV/VCR	TVVCR	Learned Only	Sur On/Off	SurOn	Srrd Mode/On Off,Aduo Lang
A/B	A / B	Learned Only	Sur Mode	SurMd	Learned Only
TV/DVD	TVDVD	Learned Only	Surround Up	SurUp	Learned Only
TV/LD	TV LD	Learned Only	Surround Dn	SurDn	Learned Only
Input	Input	DVD/Tuner,Input Select	PIP	PIP	Learned Only
TV/DSS	TVDSS	Learned Only	PIP Move	PIP M	Learned Only
Play	Play	Play	PIP Swap	PIP S	Learned Only
Stop	Stop	Stop	Program	Progm	Learned Only
Search Fwd	SrchF	Fast Forward	Sleep	Sleep	Learned Only
Search Rev	SrchR	Rewind	On	On	On, Power On/Off

INSTALLER KEY CODES RECEIVER

KEY FUNCTION	UNO-S1	RECEIVER
Off	Off	Off, Power On/Off
11	11	Learned Only
12	12	Learned Only
13	13	Learned Only
14	14	Learned Only
15	15	Learned Only
16	16	Learned Only
Bright	Brght	Learned Only
Dim	Dim	Learned Only
Close	Close	Learned Only
Open	Open	Learned Only
Halt	Halt	Learned Only
AM/FM	AM/FM	Learned Only
Cue	Cue	Learned Only
Disk Up	DiskU	Learned Only
Disk Down	DiskD	Learned Only
Info	Info	Learned Only
External Src	ExtSr	External AV Source
Live/Intro	Intro	Intro,Search,Scan
Menu	Menu	Menu
Back	Back	Clear
Fav Channel	FavCh	Mark
Display Fmt	DFrmt	FormatWide,Zoom,Aspect
SAP	SAP	Learned Only
Slow	Slow	Slow
PIP On	PIPOn	Learned Only
PIP Off	PIPOf	Learned Only
PIP Freeze	PIPFr	Learned Only
PIP Input	PIPIn	Learned Only

KEY FUNCTION	UNO-S1	RECEIVER
PIP Chan Up	PIP CU	Learned Only
PIP Chan Dn	PIP CD	Learned Only
Input 1	In 1	CD
Input 2	In 2	Tuner
Input 3	In 3	DVD, LD
Input 4	In 4	VCR, VID1
Input 5	In 5	VID5,AV1,VCR,BNC
Input 6	In 6	TV, VID2
Input 7	In 7	LD, VID3
Input 8	In 8	AUX, VID4
Input 9	In 9	DAT, Cable
Input 10	In 10	Phono SAT

INSTALLER

KEY CODES

AMP/MISC AUDIO

KEY FUNCTION	UNO-S1	AMP/MISC AUDIO	KEY FUNCTION	UNO-S1	AMP/MISC AUDIO
1	1	Digit 1	Pause	Pause	Pause
2	2	Digit 2	Record	Recrd	Record
3	3	Digit 3	Menu	Menu	Menu, Program
4	4	Digit 4	Menu Up	MenuU	Menu Up, Adjust Up
5	5	Digit 5	Menu Dn	MenuD	Menu Dn, Adjust Dn
6	6	Digit 6	Menu Left	MenuL	Menu Left
7	7	Digit 7	Menu Right	MenuR	Menu Right
8	8	Digit 8	Select	Sel	Menu Select, Cont
9	9	Digit 9	Exit	Exit	Exit, Cancel
0	0	Digit 0	Display	Displ	Display, OSD, Info
Volume Up	VolUp	Volume Up	Guide	Guide	Learned Only
Volume Down	VolDn	Volume Down	Page Up	PageU	Adjust Up
Mute	Mute	Mute	Page Down	PageD	Adjust Down
Channel Up	Ch Up	Preset Up	Disk	Disk	Learned Only
Channel Dn	Ch Dn	Preset Down	Plus 10	Pls10	Band, FM/AM
Power	Power	Power On/Off	Open/Close	Op/Cl	Learned Only
Enter	Enter	5.1, Prologic	Random	Randm	Learned Only
Prev Channel	PrvCh	Repeat	Track Fwd	TkFwd	Skip Up
TV/Video	TVVid	Learned Only	Track Rev	TkRev	Skip Down
TV/VCR	TVVCR	Learned Only	Sur On/Off	SurOn	Srrd Mode/On Off,Aduo Lang
A/B	A / B	Learned Only	Sur Mode	SurMd	Learned Only
TV/DVD	TVDVD	Learned Only	Surround Up	SurUp	Learned Only
TV/LD	TV LD	Learned Only	Surround Dn	SurDn	Learned Only
Input	Input	Bypass,Input Slct	PIP	PIP	Learned Only
TV/DSS	TVDSS	Learned Only	PIP Move	PIP M	Learned Only
Play	Play	Play	PIP Swap	PIP S	Learned Only
Stop	Stop	Stop	Program	Progm	Learned Only
Search Fwd	SrchF	Fast Forward	Sleep	Sleep	Learned Only
Search Rev	SrchR	Rewind	On	On	On, Power On/Off

INSTALLER KEY CODES AMP/MISC AUDIO

KEY FUNCTION	UNO-S1	AMP/MISC AUDIO	KEY FUNCTION	UNO-S1	AMP/MISC AUDIO
Off	Off	Off, Power On/Off	PIP Chan Up	PIP CU	Learned Only
11	11	Learned Only	PIP Chan Dn	PIP CD	Learned Only
12	12	Learned Only	Input 1	In 1	CD
13	13	Learned Only	Input 2	In 2	Tuner
14	14	Learned Only	Input 3	In 3	DVD, LD
15	15	Learned Only	Input 4	In 4	TAPE, MD
16	16	Learned Only	Input 5	In 5	VCR, VID1
Bright	Brght	Learned Only	Input 6	In 6	TV, VID2
Dim	Dim	Learned Only	Input 7	In 7	LD, VID3
Close	Close	Learned Only	Input 8	In 8	AUX, VID4
Open	Open	Learned Only	Input 9	In 9	DAT, Cable
Halt	Halt	Learned Only	Input 10	In 10	Phono, SAT
AM/FM	AM/FM	Learned Only			
Cue	Cue	Learned Only			
Disk Up	DiskU	Learned Only			
Disk Down	DiskD	Learned Only			
Info	Info	Learned Only			
External Src	ExtSr	External AV Source			
Live/Intro	Intro	Intro, Search, Scan			
Menu	Menu	Learned Only			
Back	Back	Clear			
Fav Channel	FavCh	Learned Only			
Display Fmt	DFrmt	Learned Only			
SAP	SAP	Learned Only			
Slow	Slow	Learned Only			
PIP On	PIPOn	Learned Only			
PIP Off	PIPOf	Learned Only			
PIP Freeze	PIPFr	Learned Only			
PIP Input	PIPIn	Learned Only			

INSTALLER

KEY CODES

CD

KEY FUNCTION	UNO-S1	CD	KEY FUNCTION	UNO-S1	CD
1	1	Digit 1, Track 1,Dsc1	Pause	Pause	Pause
2	2	Digit 2, Track 2,Dsc2	Record	Recrd	Record
3	3	Digit 3, Track 3,Dsc3	Menu	Menu	Disk, Edit
4	4	Digit 4, Track 4,Dsc4	Menu Up	MenuU	Menu Up
5	5	Digit 5, Track 5,Dsc5	Menu Dn	MenuD	Menu Down
6	6	Digit 6, Track 6,Dsc6	Menu Left	MenuL	Menu Left
7	7	Digit 7, Track 7,Dsc7	Menu Right	MenuR	Menu Right
8	8	Digit 8,Track 8,Dsc8	Select	Sel	Menu Select, Cont
9	9	Digit 9, Track 9,Dsc9	Exit	Exit	Exit, Cancel
0	0	Digit 0, Trck10,Dsc10	Display	Displ	Display, OSD, Info
Volume Up	VolUp	Volume Up	Guide	Guide	Group,Magazine
Volume Down	VolDn	Volume Down	Page Up	PageU	Disk Skip, Disk Up
Mute	Mute	Mute	Page Down	PageD	Disk Down
Channel Up	Ch Up	Learned Only	Disk	Disk	Learned Only
Channel Dn	Ch Dn	Learned Only	Plus 10	Pls10	+10, +100
Power	Power	Power On/Off	Open/Close	Op/Cl	Learned Only
Enter	Enter	Set	Random	Randm	Learned Only
Prev Channel	PrvCh	Repeat	Track Fwd	TkFwd	Skip Up
TV/Video	TVVid	Learned Only	Track Rev	TkRev	Skip Down
TV/VCR	TVVCR	Learned Only	Sur On/Off	SurOn	Learned Only
A/B	A / B	Learned Only	Sur Mode	SurMd	Learned Only
TV/DVD	TVDVD	Learned Only	Surround Up	SurUp	Learned Only
TV/LD	TV LD	Learned Only	Surround Dn	SurDn	Learned Only
Input	Input	DVD/Tuner Input Select	PIP	PIP	Learned Only
TV/DSS	TVDSS	Learned Only	PIP Move	PIP M	Learned Only
Play	Play	Play	PIP Swap	PIP S	Learned Only
Stop	Stop	Stop	Program	Progm	Learned Only
Search Fwd	SrchF	Fast Forward	Sleep	Sleep	Learned Only
Search Rev	SrchR	Rewind	On	On	On, Power On/Off



**INSTALLER
KEY CODES
CD**

KEY FUNCTION	UNO-S1	CD	KEY FUNCTION	UNO-S1	CD
Off	Off	Off, Power On/Off	PIP Chan Up	PIPCU	Learned Only
11	11	Learned Only	PIP Chan Dn	PIP CD	Learned Only
12	12	Learned Only	Input 1	In 1	CD
13	13	Learned Only	Input 2	In 2	Tuner
14	14	Learned Only	Input 3	In 3	DVD, LD
15	15	Learned Only	Input 4	In 4	Tape, MD
16	16	Learned Only	Input 5	In 5	VCR, VID1
Bright	Brght	Learned Only	Input 6	In 6	TV, VID2
Dim	Dim	Learned Only	Input 7	In 7	LD, VID3
Close	Close	Learned Only	Input 8	In 8	AUX, VID4
Open	Open	Learned Only	Input 9	In 9	DAT, Cable
Halt	Halt	Learned Only	Input 10	In 10	Phono, SAT
AM/FM	AM/FM	Learned Only			
Cue	Cue	Learned Only			
Disk Up	DiskU	Learned Only			
Disk Down	DiskD	Learned Only			
Info	Info	Learned Only			
External Src	ExtSr	CD/CDR/MD,Input Select			
Live/Intro	Intro	Intro,Search,Scan			
Menu	Menu	Menu, Program			
Back	Back	Track, Clear			
Fav Channel	FavCh	Finalize, Index			
Display Fmt	DFrmt	Learned Only			
SAP	SAP	Learned Only			
Slow	Slow	Learned Only			
PIP On	PIPOn	Learned Only			
PIP Off	PIPOf	Learned Only			
PIP Freeze	PIPFr	Learned Only			
PIP Input	PIPIIn	Learned Only			

INSTALLER

KEY CODES

HOME CONTROL

KEY FUNCTION	UNO-S1	HOME CONTROL	KEY FUNCTION	UNO-S1	HOME CONTROL
1	1	Digit 1	Pause	Pause	Pause
2	2	Digit 2	Record	Recrd	Record
3	3	Digit 3	Menu	Menu	Menu
4	4	Digit 4	Menu Up	MenuU	Menu Up, Mode
5	5	Digit 5	Menu Dn	MenuD	Menu Dn, Timer
6	6	Digit 6	Menu Left	MenuL	Menu Left,Oscillate
7	7	Digit 7	Menu Right	MenuR	Menu Right,Speed
8	8	Digit 8	Select	Sel	Menu Select, Light
9	9	Digit 9	Exit	Exit	Exit, Cancel
0	0	Digit 0	Display	Displ	Learned Only
Volume Up	VolUp	Volume Up	Guide	Guide	Learned Only
Volume Down	VolDn	Volume Down	Page Up	PageU	Learned Only
Mute	Mute	Mute	Page Down	PageD	Learned Only
Channel Up	Ch Up	Bright,Raise Up	Disk	Disk	Learned Only
Channel Dn	Ch Dn	Dim,Lower Down	Plus 10	Pls10	Learned Only
Power	Power	Power On/Off	Open/Close	Op/Cl	Learned Only
Enter	Enter	Learned Only	Random	Randm	Learned Only
Prev Channel	PrvCh	Learned Only	Track Fwd	TkFwd	Learned Only
TV/Video	TVVid	Learned Only	Track Rev	TkRev	Learned Only
TV/VCR	TVVCR	Learned Only	Sur On/Off	SurOn	Learned Only
A/B	A / B	Learned Only	Sur Mode	SurMd	Learned Only
TV/DVD	TVDVD	Learned Only	Surround Up	SurUp	Learned Only
TV/LD	TV LD	Learned Only	Surround Dn	SurMd	Learned Only
Input	Input	Home, Source	PIP	PIP	Learned Only
TV/DSS	TVDSS	Learned Only	PIP Move	PIP M	Learned Only
Play	Play	Play	PIP Swap	PIP S	Learned Only
Stop	Stop	Stop	Program	Progm	Learned Only
Search Fwd	SrchF	Fast Forward,Open	Sleep	Sleep	Learned Only
Search Rev	SrchR	Rewind, Close	On	On	On, Power On/Off

INSTALLER KEY CODES HOME CONTROL

KEY FUNCTION	UNO-S1	HOME CONTROL	KEY FUNCTION	UNO-S1	HOME CONTROL
Off	Off	Off, Power On/Off	PIP Chan Up	PIP CU	Learned Only
11	11	Learned Only	PIP Chan Dn	PIP CD	Learned Only
12	12	Learned Only	Input 1	In 1	Source/Scene 1
13	13	Learned Only	Input 2	In 2	Source/Scene 2
14	14	Learned Only	Input 3	In 3	Source/Scene 3
15	15	Learned Only	Input 4	In 4	Source/Scene 4
16	16	Learned Only	Input 5	In 5	Source/Scene 5
Bright	Brght	Learned Only	Input 6	In 6	Source/Scene 6
Dim	Dim	Learned Only	Input 7	In 7	Source/Scene 7
Close	Close	Learned Only	Input 8	In 8	Source/Scene 8
Open	Open	Learned Only	Input 9	In 9	Source/Scene 9
Halt	Halt	Learned Only	Input 10	In 10	Source/Scene 10
AM/FM	AM/FM	Learned Only			
Cue	Cue	Learned Only			
Disk Up	DiskU	Learned Only			
Disk Down	DiskD	Learned Only			
Info	Info	Learned Only			
External Src	ExtSr	External Source			
Live/Intro	Intro	Learned Only			
Menu	Menu	Learned Only			
Back	Back	Learned Only			
Fav Channel	FavCh	Learned Only			
Display Fmt	DFrmt	Learned Only			
SAP	SAP	Learned Only			
Slow	Slow	All On			
PIP On	PIPOn	Learned Only			
PIP Off	PIPOf	Learned Only			
PIP Freeze	PIPFr	Learned Only			
PIP Input	PIPIn	Learned Only			

INSTALLER SOURCE NAMES

UNO-S1	UNO-S2	UNO-S1	UNO-S2	UNO-S1	UNO-S2
Aux	AUX		CustomName3	DVD 3	DVD Player 3
Aux 1	AUX 1		CustomName4	FDoor	Front Door
Aux 2	AUX 2		CustomName5	Hers	Her Music
Blues	Blues		CustomName6	His	His Music
Cable	Cable		CustomName7	www.	Intrnet Radio
Cbl 1	Cable 1		CustomName8	Jazz	Jazz
Cbl 2	Cable 2		CustomName9	Kids	Kids Music
Cbl 3	Cable 3		CustomName10	LD	Laser Disk
CDCh	CD Changer	Dance	Dance Music	MSvr	Media Server
CDCh1	CD Changer 1	DigCb	Digitl Cable	MSvr1	Media Svr 1
CDCh2	CD Changer 2	DSS	DSS Receiver	MSvr2	Media Svr 2
CDCh3	CD Changer 3	DSS 1	DSS 1	MSvr3	Media Svr 3
CD	CD Player	DSS 2	DSS 2	MiniD	Mini Disk
CD 1	CD Player 1	DSS 3	DSS 3	Misc	Misc Lrnd IR
CD 2	CD Player 2	DVDC	DVD Changer	Mood	Mood Music
CD 3	CD Player 3	DVDC1	DVD Changr1	MornM	MorningMusic
Class	Classical	DVDC2	DVD Changr2	MP3	MP3
Compr	Computer	DVDC3	DVD Changr3	Oldes	Oldies
Cntry	Country	DVD	DVD Player	Pop	Pop
	CustomName1	DVD 1	DVD Player 1	RDoor	Rear Door
	CustomName2	DVD 2	DVD Player 2	Relig	Religious

INSTALLER SOURCE NAMES

UNO-S1	UNO-S2	UNO-S1	UNO-S2
RepTV	ReplayTV	Tun 1	Tuner 1
Rock	Rock	Tun 2	Tuner 2
Sat	Satellite	Tun 3	Tuner 3
Sat 1	Satellite 1	TV	TV
Sat 2	Satellite 2	VCR	VCR
Sat 3	Satellite 3	VCR 1	VCR 1
SatRd	Sat Radio	VCR 2	VCR 2
Src 1	Source 1	<XM>	<<<XM>>>
Src 2	Source 2	XM 1	XM 1
Src 3	Source 3	XM 2	XM 2
Src 4	Source 4	XM 3	XM 3
Src 5	Source 5	XM	XM Radio
Src 6	Source 6		
Src 7	Source 7		
Src 8	Source 8		
Spcl	Special		
Tape	Tape		
Tape1	Tape 1		
Tape2	Tape 2		
TiVo	TIVO		
Tuner	Tuner		

Source Information Form

	Source 1	Source 2	Source 3	Source 4	Source 5	Source 6
Source Name	Tuner					
Manufacturer	Russound					
Model #	N/A					
IR Command Type *	Peripheral					
IR Device Code (learned or 4-digit)	N/A					
Numeric IR (Y or N)	N					
Highest Number	N/A					
Auto Play (Y or N)	N					
Source Volume Trim (dB) -16dB<->0dB						
Source Select Command						
Power Mgmt Power On Command	N/A					
Power Off Command	N/A					

*IR Command Type, e.g., Cable, DVD, Tuner, CD, etc.

Zone Information Form

Zone Number	Zone Name	Zone Volume Trim -16dB <-> 0dB	System On Enable	Party Mode Enable	Master Keypad Enable	Mute Enable
1			Y N	Y N	Y N	Y N
2			Y N	Y N	Y N	Y N
3			Y N	Y N	Y N	Y N
4			Y N	Y N	Y N	Y N
5			Y N	Y N	Y N	Y N
6			Y N	Y N	Y N	Y N

(Default setting is bolded)

Macro Editor Form

Macro ID Number	Macro Name	Command 1	Command 2	Command 3	Command 4	Command 5	Command 6	Command 7	Command 8	Command 9	Command 10

Macro ID Number	Macro Name	Command 1	Command 2	Command 3	Command 4	Command 5	Command 6	Command 7	Command 8	Command 9	Command 10

SAMPLE CONFIGURATIONS MULTIPLE CONTROLLERS WITH ONE TUNER

Sharing a single CAM6.6T (internal tuner) with multiple controllers

This arrangement can support up to six CAM6.6 units for up to 36 zones/6 sources. Each additional CAM6.6 must have an incremental Controller ID # and RNET link. Audio from the source tuner can be split if shared by all controllers.

CAM6.6T -
Controller Setup Menu: Controller ID = 1
Peripheral Setup Menu: Controller ID = All Controllers

Output/Input Switch = Internal Source Output
RCA cable connected to Source 1

CAM6.6 (no tuner installed) -
Controller Setup Menu: Controller ID = 2
Source Setup Menu: Basic Setup Procedure:
Source # = 1; Source Name = Tuner;
Command Type = Peripheral

Output/Input Switch = Input
RCA cable connected to Source 1

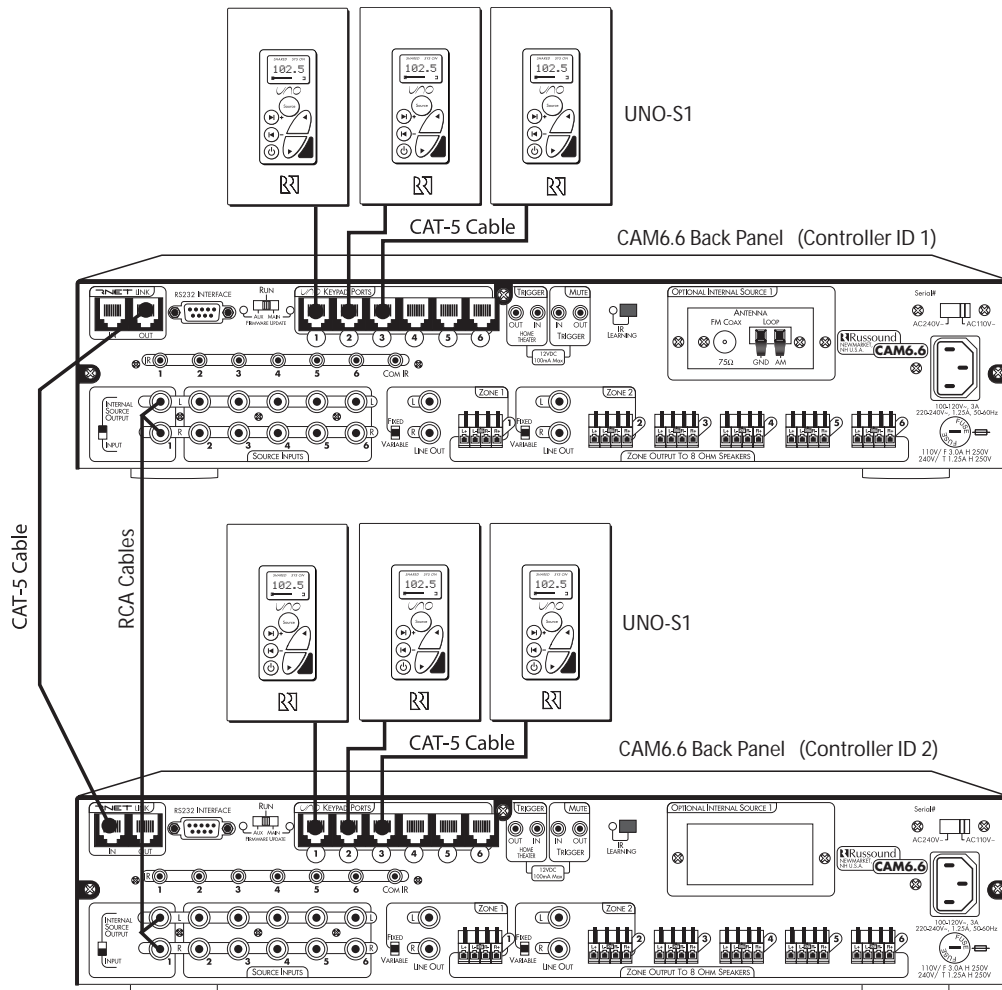

SAMPLE CONFIGURATIONS

MULTIPLE CONTROLLERS WITH ST2 DUAL TUNER

Sharing an ST2 Dual Tuner with multiple CAM6.6 controllers (no built-in tuners)

The configuration below is suitable for 7 to 12 zones that can all access the ST2 Dual Tuner. This configuration uses RCA "Y" cables from the ST2 Tuner source outputs to connect to both CAM6.6 source inputs.

CAM6.6 (no tuner installed) -

Controller Setup Menu: Controller ID = 1
 Source Setup Menu: Basic Setup Procedure:
 Source # = 1; Source Name = Tuner 1;
 Command Type = Peripheral
 Source # = 2; Source Name = Tuner 2;
 Command Type = Peripheral
 Output/Input Switch = Input
 RCA cable connected from ST2 Tuner 1 audio output

to Source 1 input on CAM6.6 (1)
 RCA cable connected from ST2 Tuner 2 audio output
 to Source 2 input on CAM6.6 (1)

CAM6.6 (no tuner installed) -

Controller Setup Menu: Controller ID = 2
 Source Setup Menu: Basic Setup Procedure:
 Source # = 1; Source Name = Tuner 1;
 Command Type = Peripheral
 Source # = 2; Source Name = Tuner 2;
 Command Type = Peripheral
 Output/Input Switch = Input
 RCA cable connected from ST2 Tuner 1 audio output
 to Source 1 input on CAM6.6 (2)
 RCA cable connected from ST2 Tuner 2 audio output
 to Source 2 input on CAM6.6 (2)

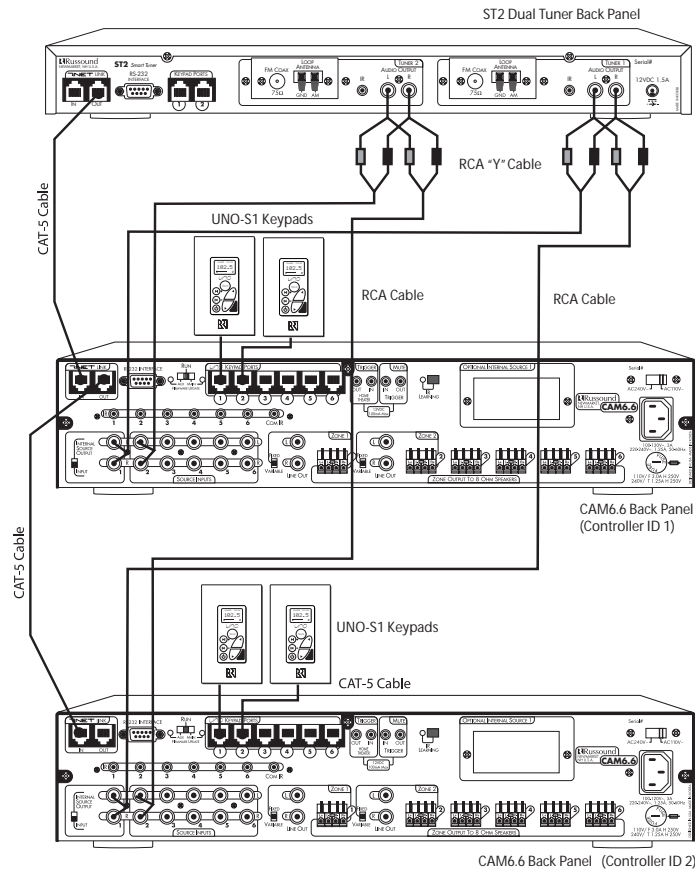

SAMPLE CONFIGURATIONS MULTIPLE CONTROLLERS WITH THREE TUNERS

Sharing an ST2 Dual Tuner with multiple CAM6.6 controllers (with and without tuners)

The configuration below is suitable for 7 to 12 zones that can access the ST2 Dual Tuner and the CAM6.6T tuner. This configuration uses RCA "Y" cables from the ST2 Tuner source outputs to connect to both CAM6.6 source inputs.

CAM6.6T -

Controller Setup Menu: Controller ID = 1
 Peripheral Setup Menu: Controller ID = All Controllers
 Source Setup Menu: Basic Setup Procedure:
 Source # = 2; Source Name = Tuner 2;
 Command Type = Peripheral
 Source # = 3; Source Name = Tuner 3;
 Command Type = Peripheral
 Output/Input Switch = Internal Source Output
 RCA cable connected from Source 1 audio output on CAM6.6T (1) to Source 1 input on CAM6.6 (2)
 RCA cable connected from ST2 Tuner 1 audio output

to Source 2 input on CAM6.6T (1)
 RCA cable connected from ST2 Tuner 2 audio output to Source 3 input on CAM6.6T (1)

CAM6.6 (no tuner installed) -

Controller Setup Menu: Controller ID = 2
 Source Setup Menu: Basic Setup Procedure:
 Source # = 1; Source Name = Tuner 1;
 Command Type = Peripheral
 Source # = 2; Source Name = Tuner 2;
 Command Type = Peripheral
 Source # = 3; Source Name = Tuner 3;
 Command Type = Peripheral
 Output/Input Switch = Input
 RCA cable connected from Source 1 audio output on CAM6.6T (1) to Source 1 input on CAM6.6 (2)
 RCA cable connected from ST2 Tuner 1 audio output to Source 2 input on CAM6.6 (2)
 RCA cable connected from ST2 Tuner 2 audio output to Source 3 input on CAM6.6 (2)

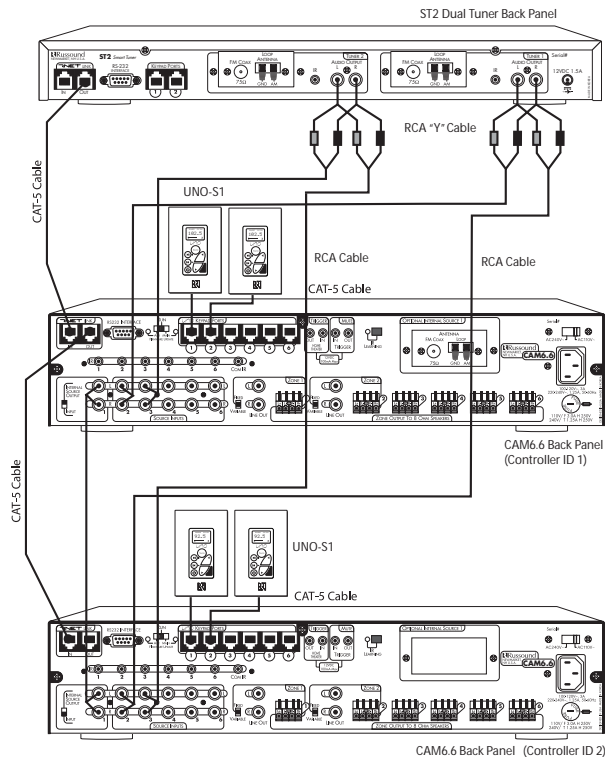



TECHNICAL SPECIFICATIONS

Dimensions:	17"W x 12"D x 3.5"H (43 x 30.5 x 9 cm)
Weight:	18 lbs. (8.1 kg)
Power Supply:	110 or 240 VAC
Fuse Rating:	110V input; F3A H 250V US and Canada 240V input; T1.25A H 250V Europe
Frequency Response:	20Hz-20kHz +/- 1dB
Watts per channel:	20 Watts RMS into 8 Ohms
THD+N:	<0.05%
Signal to Noise Ratio:	>88dB
Audio Source Inputs:	6 (including internal tuner)
Input Impedance:	50 kohm
Audio Zone Outputs:	6 Speaker Level (8 Ohms) (2 Line Level)
Max Source Audio Input:	2.2 Vrms
Max Zone Variable Line Audio Output:	2.2 Vrms
Max Zone Fixed Line Audio Output:	2.2 Vrms
Trigger Outputs:	1 Common. 12VDC 100mA
Trigger Inputs:	1 Home Theater 12VDC max
Frequency Range:	AM 530 - 1710 kHz FM 87.7 - 107.9 MHz
Antenna impedance:	AM: 300 Ohm balanced
Impedance:	FM: 75 Ohm unbalanced
Sensitivity @ S/N:	AM: 20dB 55dBu FM: 30dB 6dB max 12dBu
Image rejection:	AM: 33dB FM: 80 DB
S/N ratio:	AM: 45 dB FM: 60 DB

WARRANTY & REPAIR



The Russound CAM6.6 is fully guaranteed against all defects in materials and workmanship for two (2) years from the date of purchase. During this period, Russound will replace any defective parts and correct any defect in workmanship without charge for either parts or labor.

For this warranty to apply, the unit must be installed and used according to its written instructions. If service is necessary, it must be performed by Russound. The unit must be returned to Russound at the owner's expense and with prior written permission. Accidental damage and shipping damage are not considered defects, nor is damage resulting from abuse or from servicing by an agency or person not specifically authorized in writing by Russound.

This Warranty does not cover:

- Damage caused by abuse, accident, misuse, negligence, or improper installation or operation
- Power surges and lightning strikes
- Normal wear and maintenance
- Products that have been altered or modified
- Any product whose identifying number, decal, serial number, etc. has been altered, defaced or removed

Russound sells products only through authorized Dealers and Distributors to ensure that customers obtain proper support and service. Any Russound product purchased from an unauthorized dealer or other source, including retailers, mail order sellers and online sellers will not be honored or serviced under existing Russound warranty policy. Any sale of products by an unauthorized source or other manner not authorized by Russound shall void the warranty on the applicable product.

Damage to or destruction of components due to application of excessive power voids the warranty on those parts. In these cases, repairs will be made on the basis of the retail value of the parts and labor. To return for repairs, the unit must be shipped to Russound at the owner's expense, along with a note explaining the nature of service required. Be sure to pack the unit in a corrugated container with at least three (3) inches of resilient material to protect the unit from damage in transit.

Before returning a unit for repair, call Russound at (603) 659-5170 for a Return Authorization number. Write this number on the shipping label and ship to:

Russound
ATTN: Service
5 Forbes Road
Newmarket, NH 03857

Due to continual efforts to improve product quality as new technology and techniques become available, Russound/FMP, Inc. reserves the right to revise system specifications without notice.







Russound®

CAM6.6

Six-Zone, Six-Source Controller

CAM6.6T

Six-Zone, Six-Source AM/FM Receiver

INSTRUCTION MANUAL

Russound
5 Forbes Road, Newmarket, NH 03857
tel 603.659.5170 • fax 603.659.5388
e-mail: tech@russound.com
www.russound.com

Copyright ©2006 Russound®. All rights reserved.
All trademarks are property of their respective owners.
Specifications subject to change without notice.
Russound is not responsible for typographical errors or omissions.
For use with CAM6.6 Rev. 1 Hardware
28-0111 Rev. 2 05/11/06